

Andy '13

DIVANI

2013

Paolo Piva



Descrizione

Rigore formale, proporzioni calibrate e geometria morbida caratterizzano Andy '13, divano dotato di un meccanismo grazie al quale lo schienale può cambiare inclinazione e passare da una posizione orizzontale, maggiormente arredativa e di segno contemporaneo, ad una posizione verticale di grande comfort per la schiena. È disponibile in versione lineare e angolare con chaise longue con rivestimenti in tessuto o pelle.

Informazioni tecniche

Telaio interno

tubolari e profilati d'acciaio

Imbottitura telaio interno

schiuma di poliuretano flessibile a freddo Bayfit®, fodera in fibra di poliestere

Cuscino schienale con rullo (AD60CP)

piuma, inserto poliuretano e fibra di poliestere, tipologia a fascia e rullo

Struttura

trafilati e profilati d'acciaio

Profili

tubi d'acciaio

Montanti divani

lamiera d'acciaio

Piedini e puntali

materiale termoplastico

Rivestimento

tessuto (profili in ecopelle) o pelle

Disegni tecnici

AD248

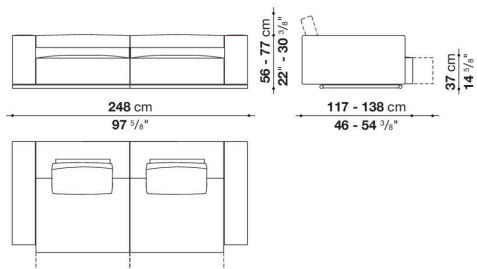

AD292

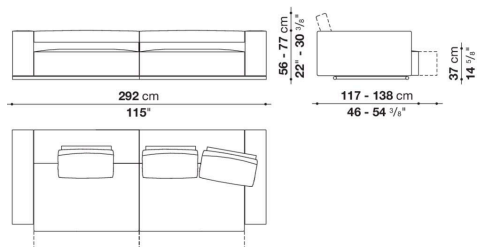

AD346

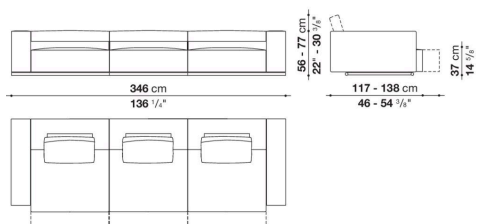

AD412

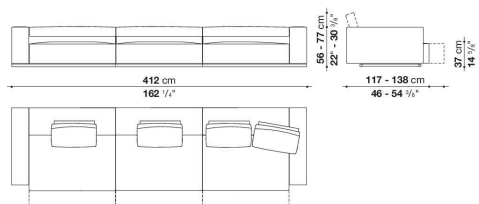

AD326AS

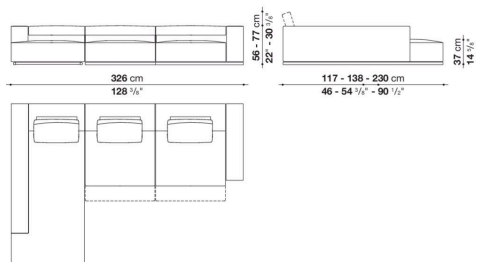

AD326AD

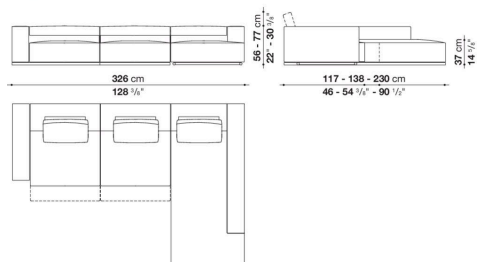

AD370AS

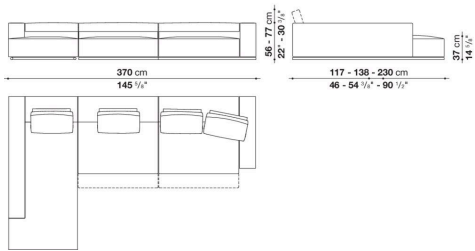

AD370AD

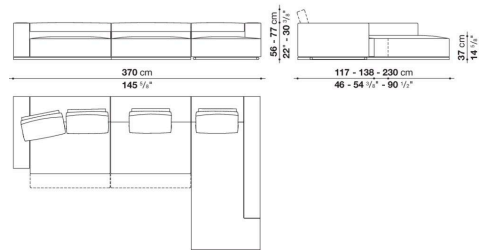

AD253S

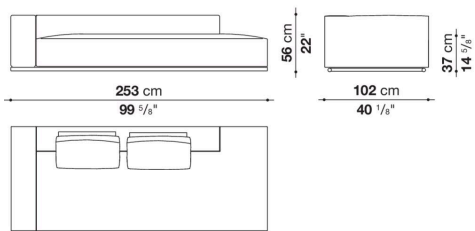

AD253D

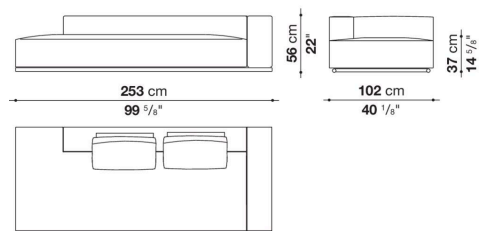

AD98P

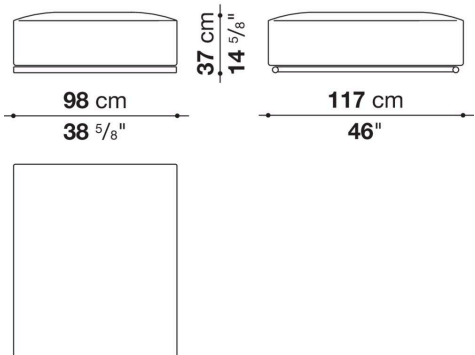

AD120P

