

Dock

DIVANI

2019

Piero Lissoni



Descrizione

Dock, nella versione con altezza della seduta alta, è un sistema di imbottiti dall'anima molteplice, altamente flessibile grazie alle innumerevoli configurazioni che i numerosi elementi della collezione sono in grado di generare. La vocazione orizzontale del progetto è sottolineata dal pianale, piattaforma dalla forte presenza materica attorno alla quale si sviluppa tutto il sistema, oltre che elemento dinamico che si allunga ai lati per formare un piano d'appoggio. Il bracciolo è sottile, in due profondità, generosamente imbottito come lo schienale. Anche i cuscini giocano con dimensioni e proporzioni, rendendo possibile la creazione di composizioni bifacciali, angolari, chaise longue, con o senza schienale, soluzioni a centro stanza ma anche più tradizionali. Completano il sistema una serie di accessori dedicati che offrono un panorama variegato di possibilità: tra i cuscini della seduta si possono infatti inserire elementi extra quali confortevoli braccioli imbottiti, mentre sul pianale si possono posizionare elementi di servizio, di appoggio per il corpo e gli oggetti in grado di garantire una maggiore personalizzazione per vivere e concepire il sistema a propria misura. La struttura di base è in acciaio. I rivestimenti sono previsti in tessuto e pelle. Dock è proposto anche nella versione con seduta rasoterra.

L'altezza dei piedini da terra è di 16,5 cm (6 1/2").

Informazioni tecniche

Telaio interno sedile (base rivestita)

tubolari e profilati d'acciaio, pannello in multistrato di legno, fodera in fibra di poliestere

Telaio interno sedile (base legno)

tubolari e profilati d'acciaio, pannello in multistrato di legno impiallacciato, legno massello

Telaio interno schienale e bracciolo

tubolari e profilati d'acciaio

Imbottitura cuscino sedile

poliuretano sagomato a densità differenziata, piuma sterilizzata, fodera in fibra di poliestere

Imbottitura cuscino schienale

piuma sterilizzata, fodera in fibra di poliestere

Piano

pannello in fibra di legno MDF impiallacciato

Capsula

acciaio

Struttura di sostegno

profilati d'acciaio

Supporto bracciolo (DA31B)

alluminio e acciaio

Piano bracciolo (DA31B)

legno massello, poliuretano sagomato a densità differenziata, fodera in fibra di poliestere

Supporto elemento di servizio

acciaio

Piano elemento di servizio

legno massello o vetro

Puntali

materiale plastico

Rivestimento

tessuto (profilo cannetè) o pelle

Disegni tecnici

DA198

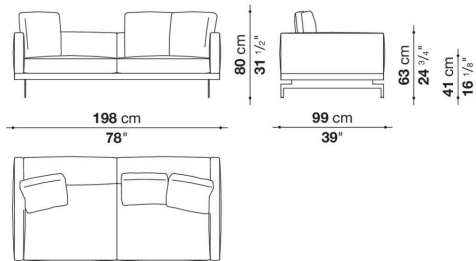

DAL198

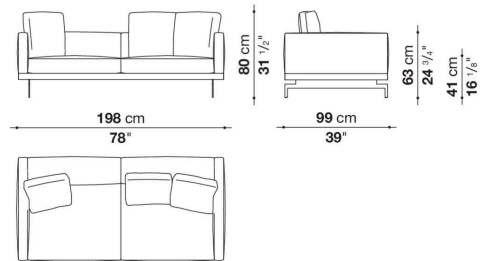

DAL239S_1

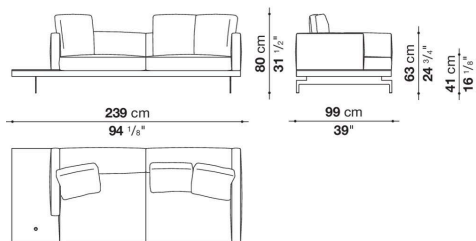

DAL239D_1

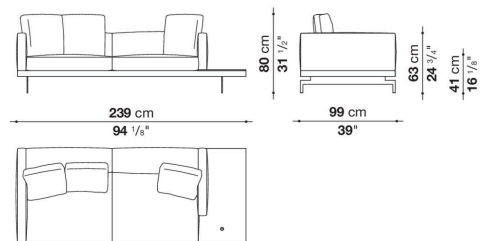

DAL239S_2

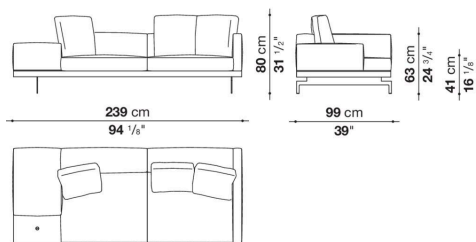

DAL239D_2

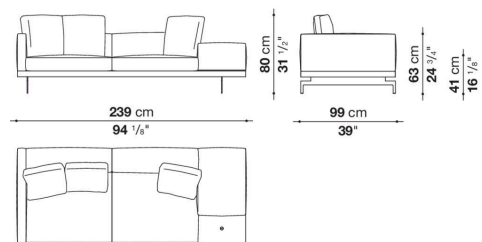

DA280_1

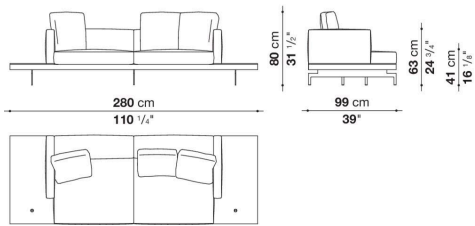

DAL280_1

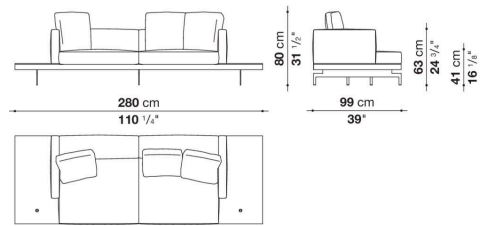

DA280_2

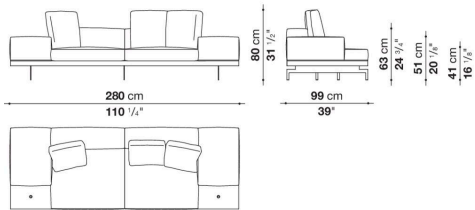

DAL280_2

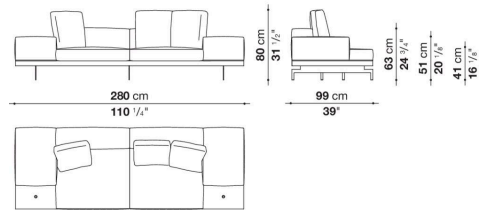

DA280S_3

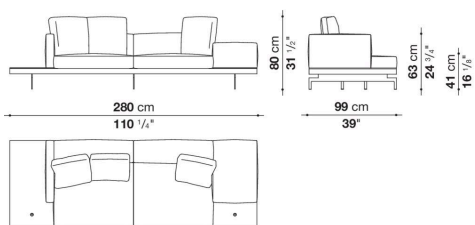

DAL280S_3

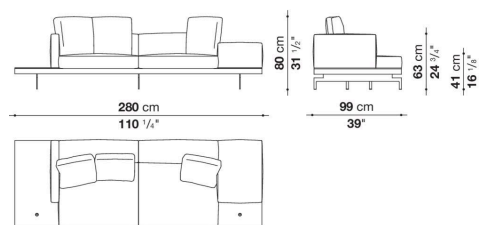

DA280D_3

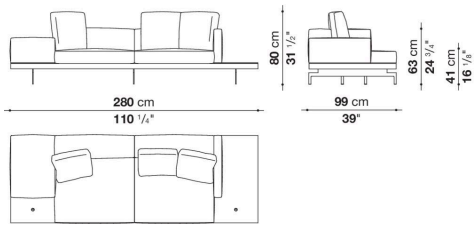

DAL280D_3

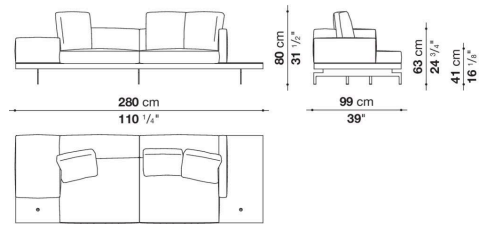

DA288

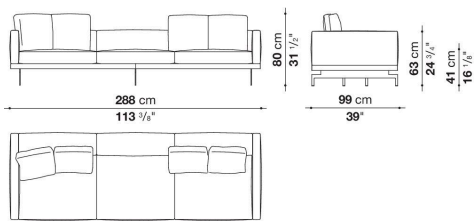

DAL288

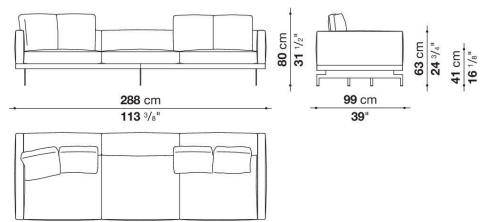

DA239S_1

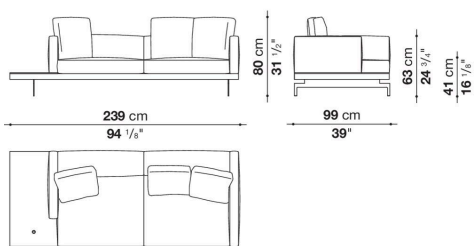

DAL329S_1

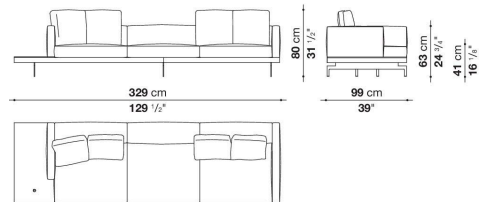

DA239D_1

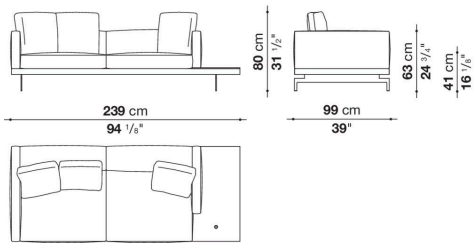

DAL329D_1

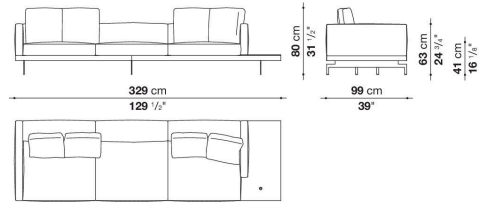

DA239S_2

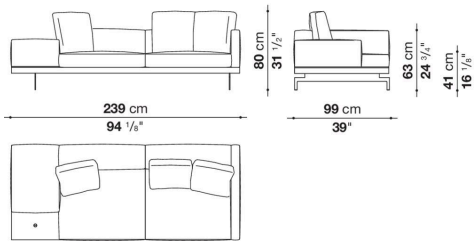

DAL329S_2

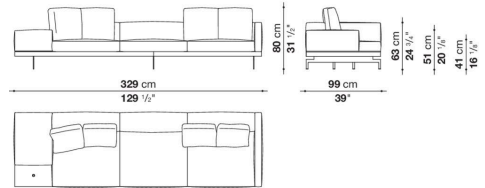

DA239D_2

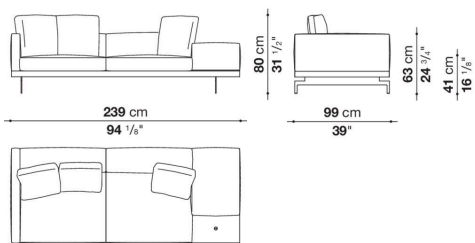

DAL329D_2

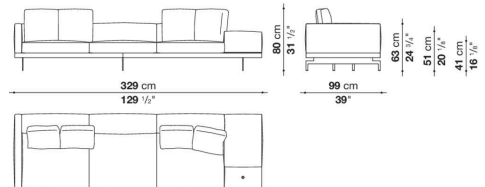

DA370_1

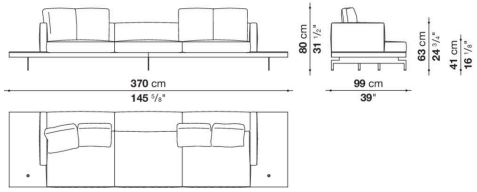

DAL370_1

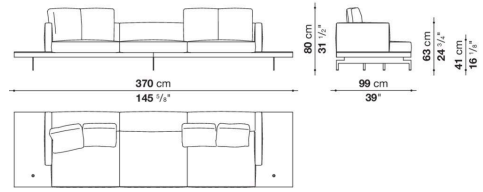

DA370_2

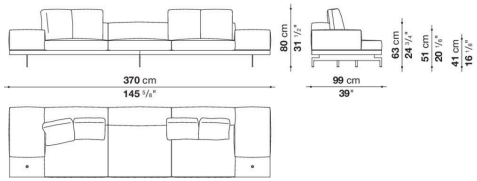

DAL370_2

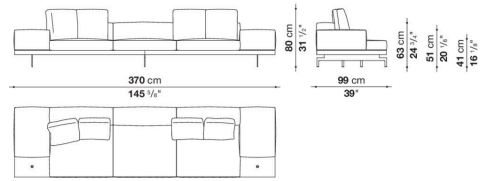

DA370S_3

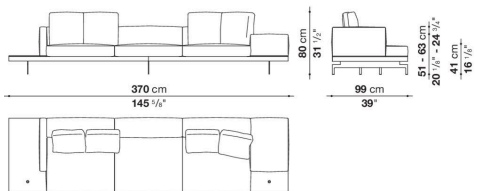

DAL370S_3

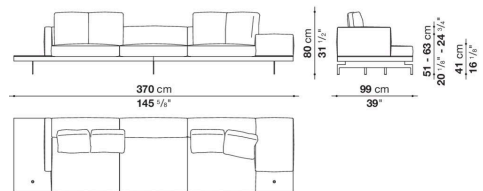

DA370D_3

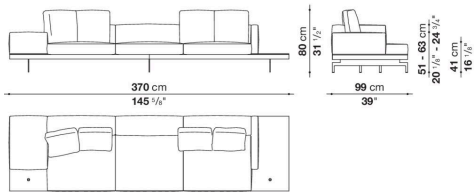

DAL370D_3

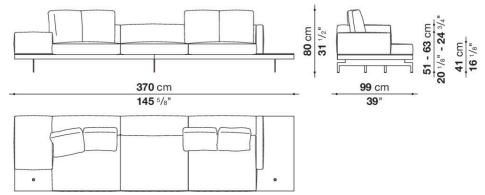

DA189TS

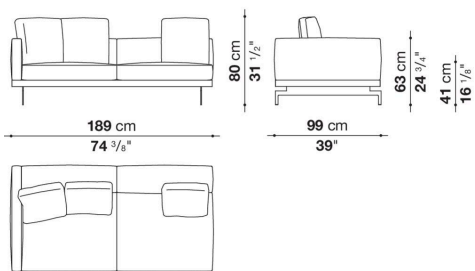

DAL189TS

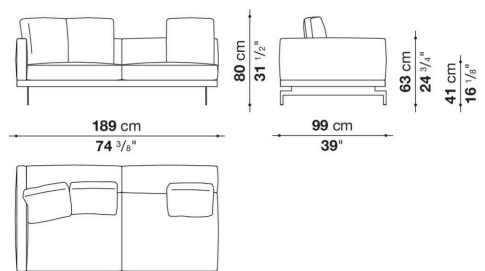

DA189TD

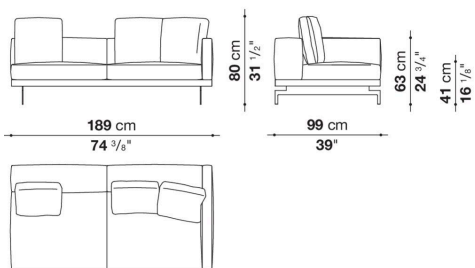

DAL189TD

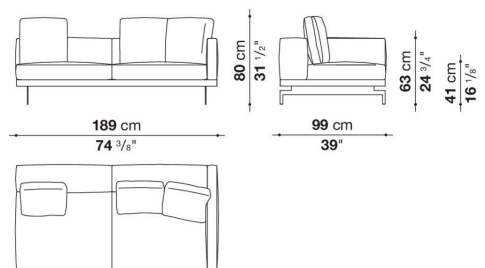

DA230TS_1

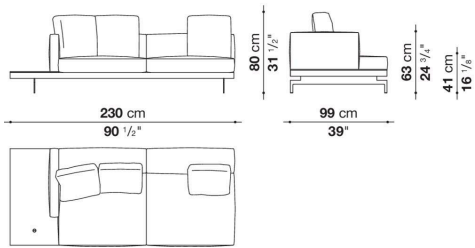

DAL230TS_1

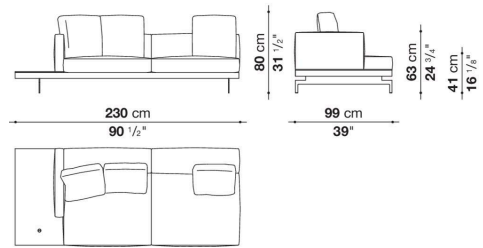

DA230TD_1

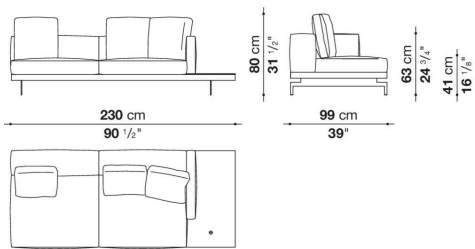

DAL230TD_1

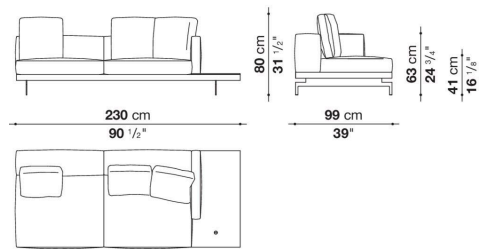

DA230TS_3

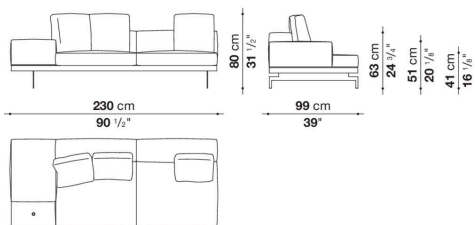

DAL230TS_3

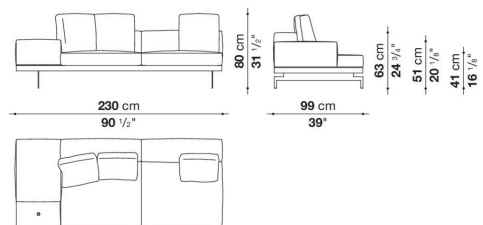

DA230TD_3

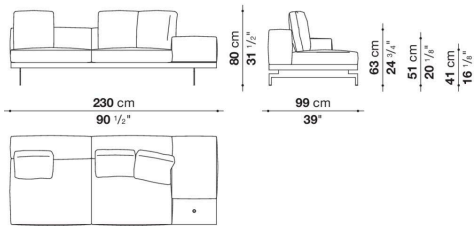

DAL230TD_3

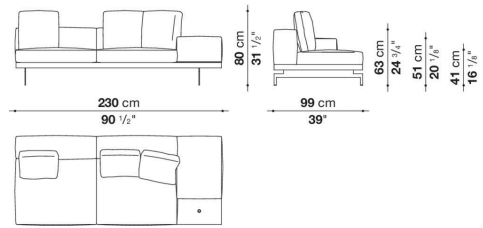

DA320TS_1

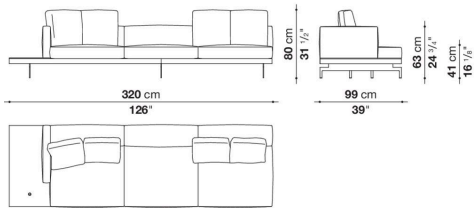

DAL320TS_1

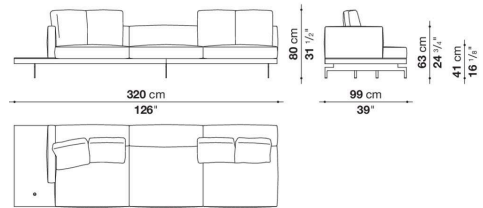

DA320TD_1

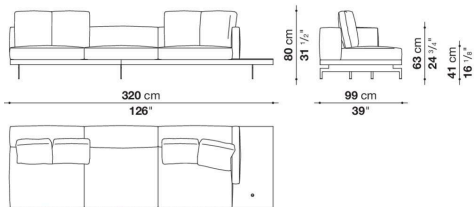

DAL320TD_1

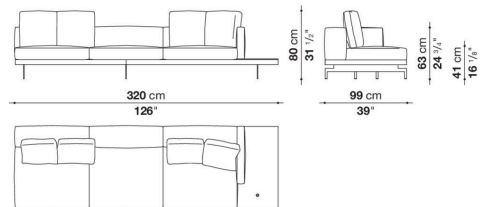

DA320TS_3

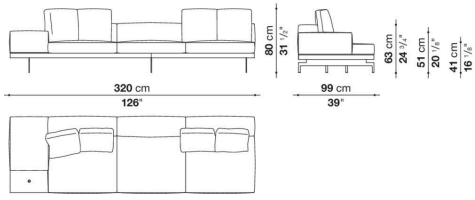

DAL320TS_3

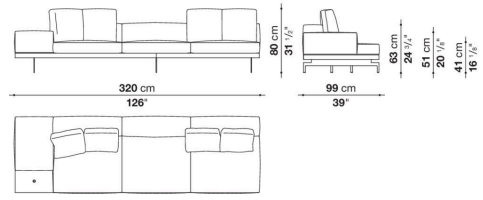

DA320TD_3

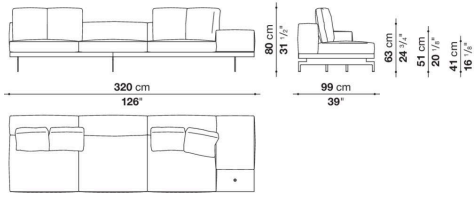

DAL320TD_3

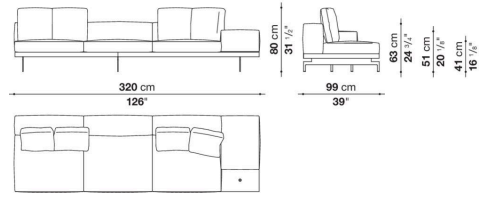

DA279AS_1

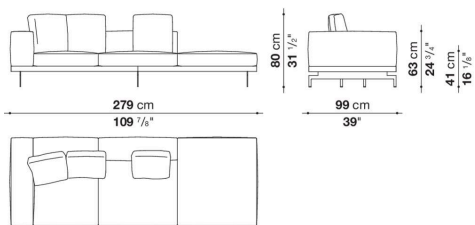

DAL279AS_1

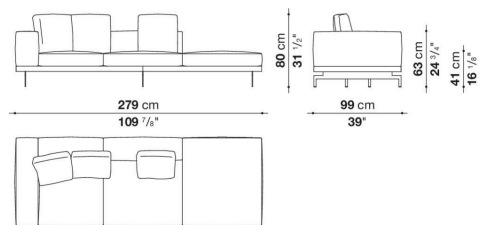

DA279AD_1

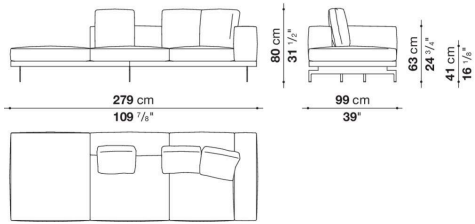

DAL279AD_1

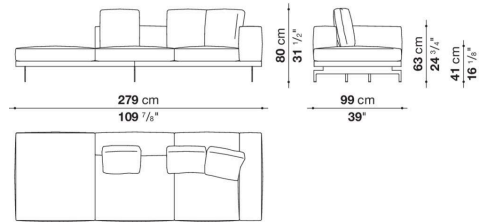

DA288AS

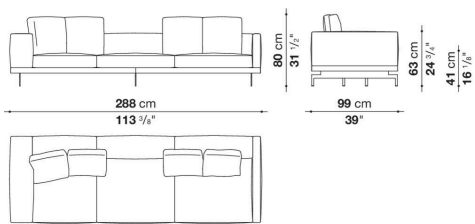

DAL288AS

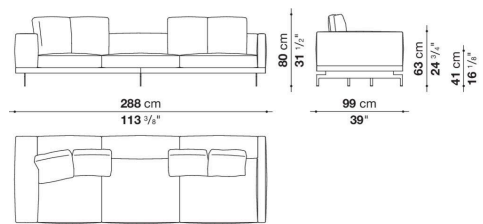

DA288AD

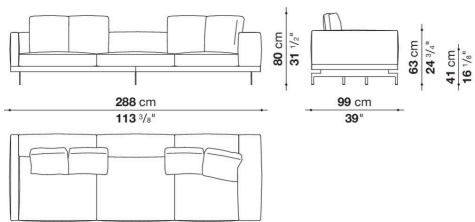

DAL288AD

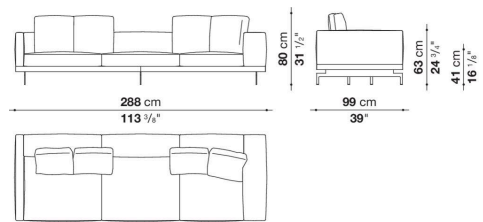

DA288AS_2

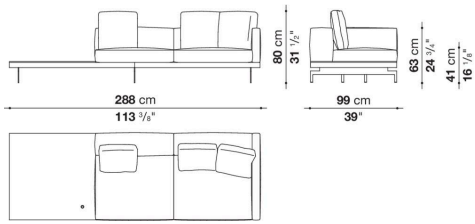

DAL288AS_2

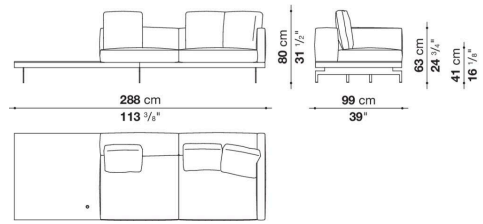

DA288AD_2

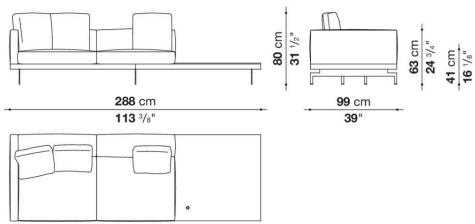

DAL288AD_2

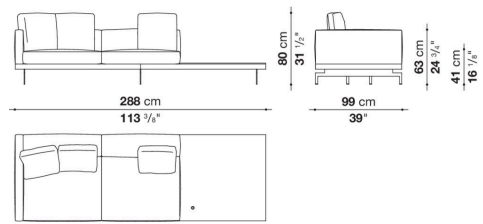

DA329AS_2

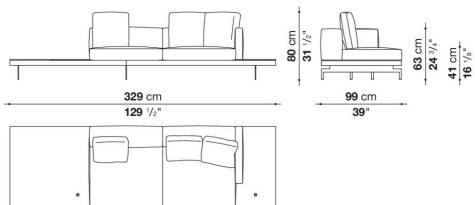

DAL329AS_2

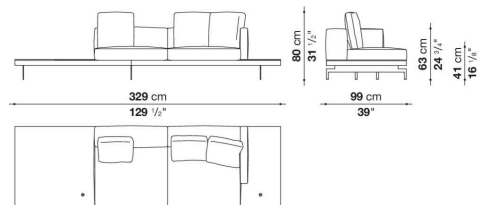

DA329AD_2

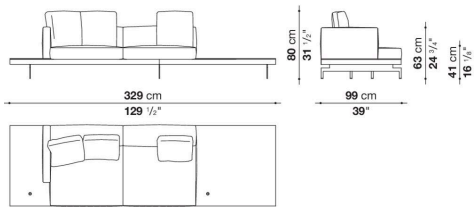

DAL329AD_2

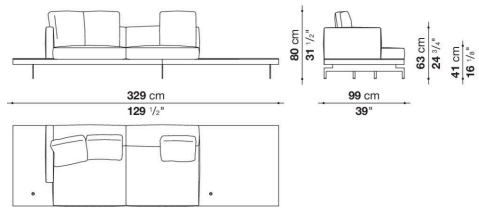

DA329AS_4

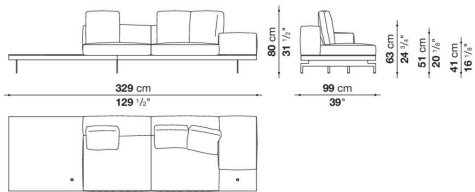

DAL329AS_4

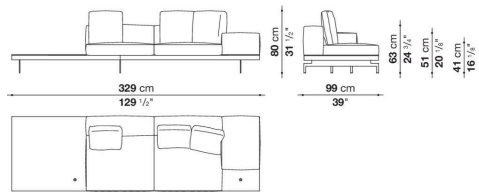

DA329AD_4

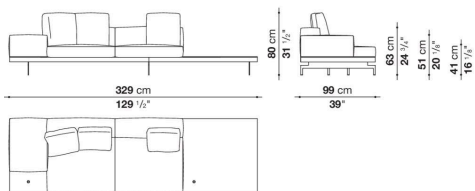

DAL329AD_4

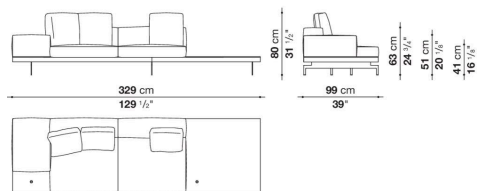

DA150LS_1

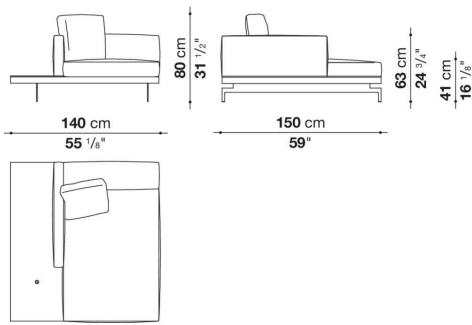

DAL150LS_1

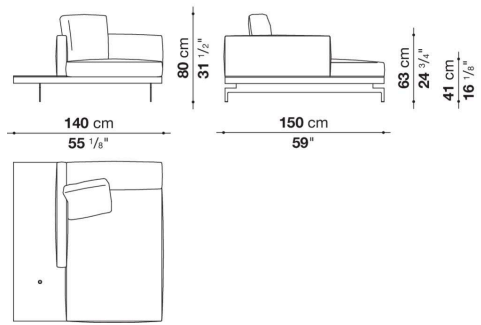

DA150LD_1

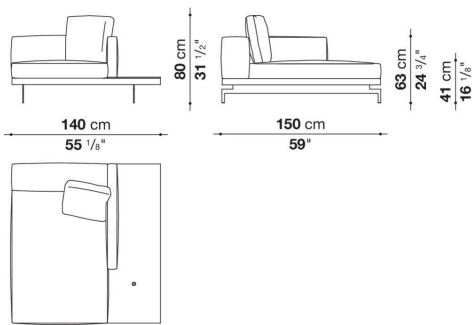

DAL150LD_1

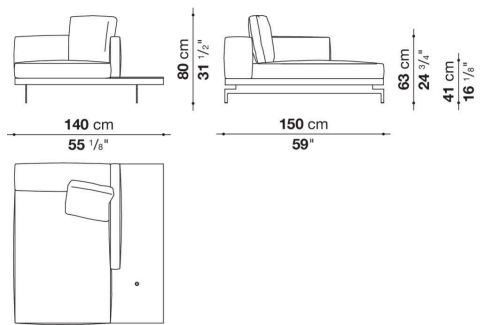

DA150LS_2

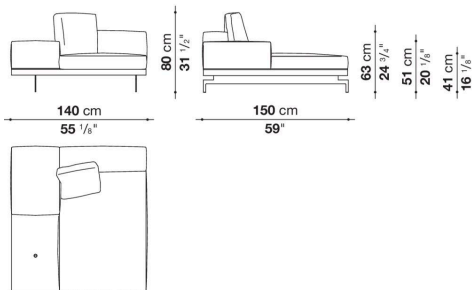

DAL150LS_2

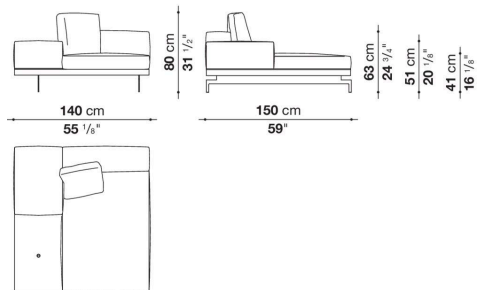

DA150LD_2

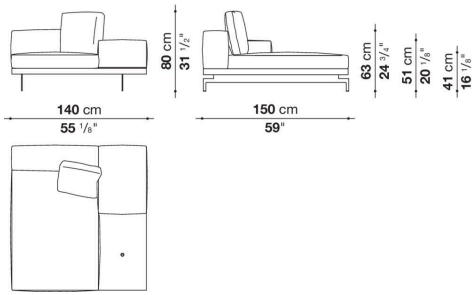

DAL150LD_2

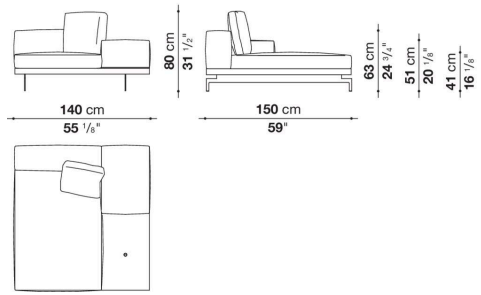

DA280P

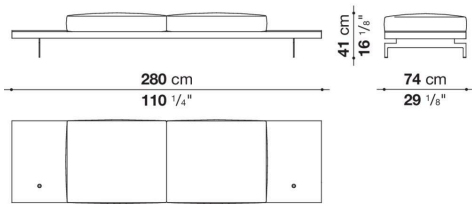

DAL280P

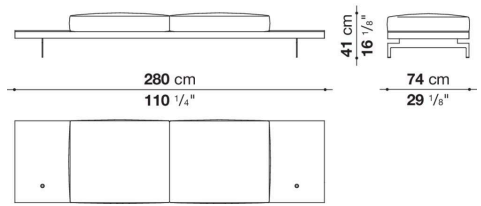

DA320PS_2

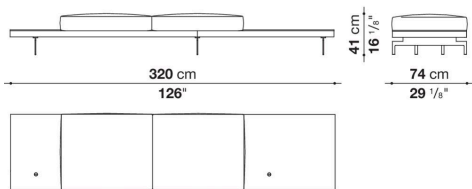

DAL320PS_2

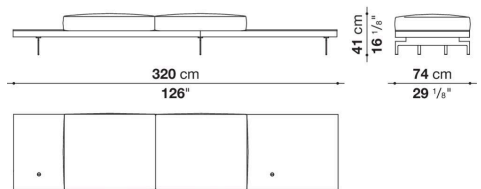

DA320PD_2

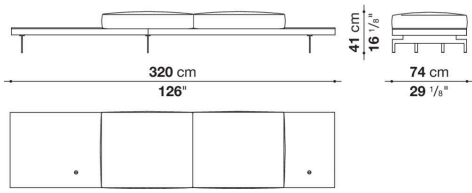

DAL320PD_2

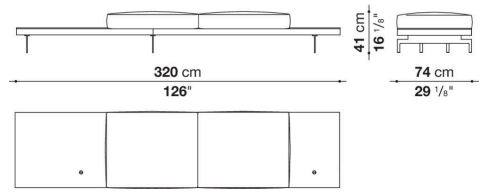

DA370P

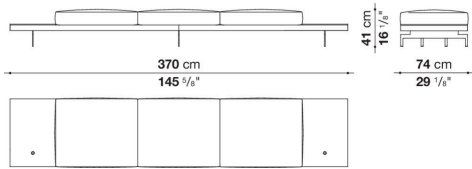

DAL370P

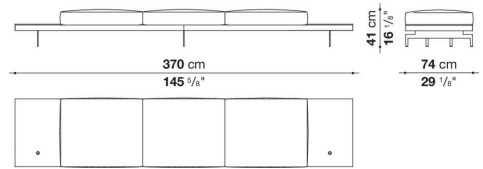

DA370PS

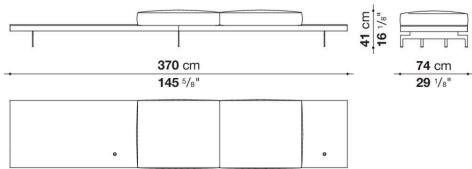

DAL370PS

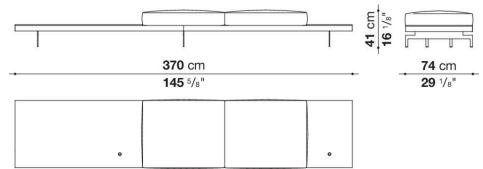

DA370PD

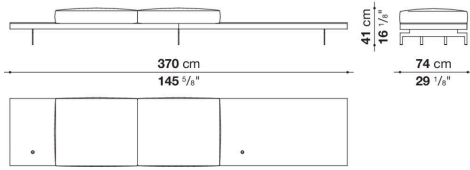

DAL370PD

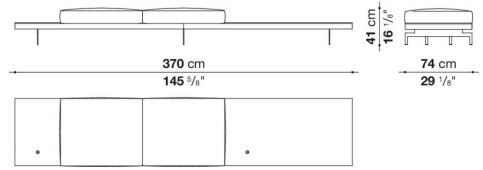

DA31B

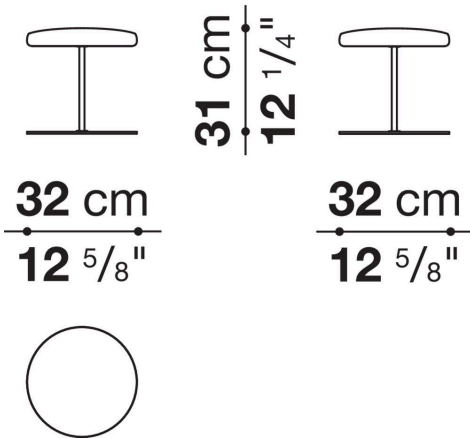

DA329D_1

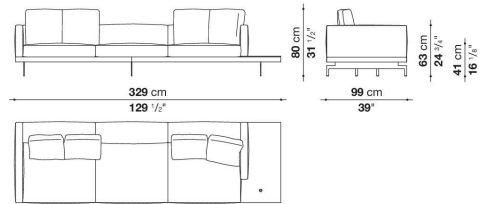

DA329D_2

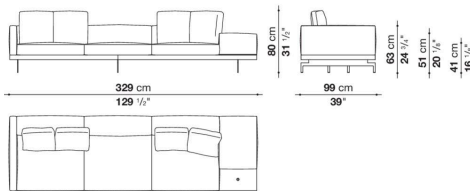

DA329S_1

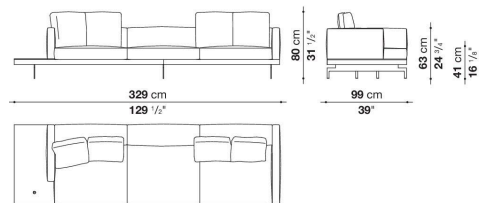

DA329S_2

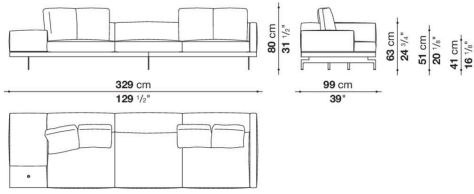

TDA31

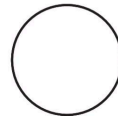
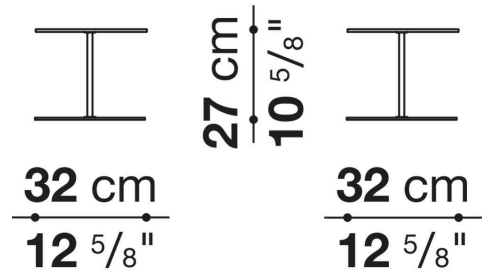

TD23R

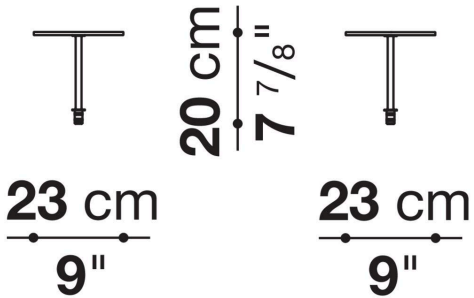

TD23RL

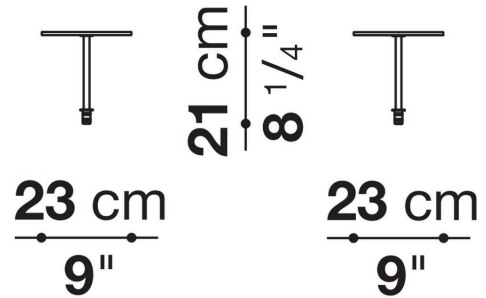

TD36

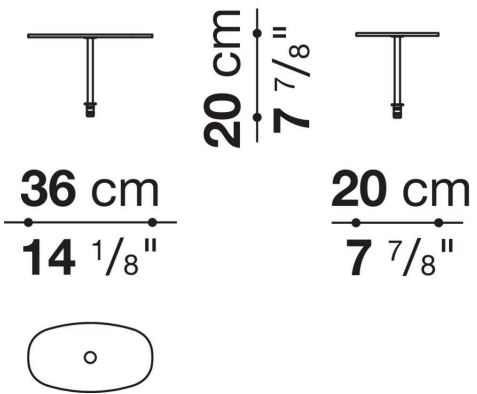

TD36L

