

---

# Dock

SOFAS

2019

Piero Lissoni



## Description

---

In the version with a 41 cm seat height, Dock is a collection of upholstered elements with a multiple soul, rendered highly flexible by the countless configurations made possible by the numerous elements included in the collection. This horizontally-spanning project is underscored by a highly textured platform: a dynamic element that extends beyond the sides of the sofa to create a support surface. The slender armrests, available in two depths, are generously padded, just like the backrest. The cushions create a play of sizes and proportions, making it possible to put together double-sided, corner and chaise longue compositions, with or without backrests, suitable for use at the centre of the room or for more traditional solutions. Dock comes with a series of accessories offering a vast array of possibilities: it is possible to insert extra elements between the seat cushions, such as comfortable padded armrests, while functional and supporting elements can be placed on the platform, ensuring further customisation possibilities so as to experience and design the system at will. The base frame is in steel. The body is upholstered in either fabric or leather. Dock also comes in a low version virtually flush with the ground. The height of the feet from ground is 16,5 cm (6 1/2").

# Technical information

---

**Seat internal frame (covered base)**

tubular steel and steel profiles, multi-layered wood panel, polyester fibre cover

**Seat internal frame (wooden base)**

tubular steel and steel profiles, veneered multi-layered wood panel, solid wood

**Back and armrest internal frame**

tubular steel and steel profiles

**Seat cushion upholstery**

shaped polyurethane of different density, sterilized down, polyester fibre cover

**Back cushion upholstery**

sterilized down, polyester fibre cover

**Top**

veneered MDF wood fibre panel

**Cap**

steel

**Support frame**

steel profiles

**Armrest support (DA31B)**

aluminium and steel

**Armrest top (DA31B)**

solid wood, shaped polyurethane of different density, polyester fibre cover

**Service element support**

steel

**Service element top**

solid wood or glass

**Ferrules**

plastic material

**Cover**

fabric (cannetè profile) or leather

# Technical drawings

**DA198**

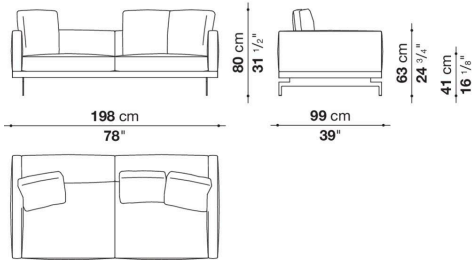

**DAL198**

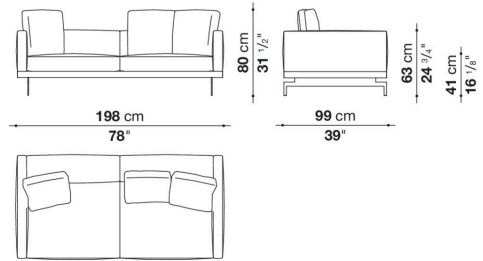

**DAL239S\_1**

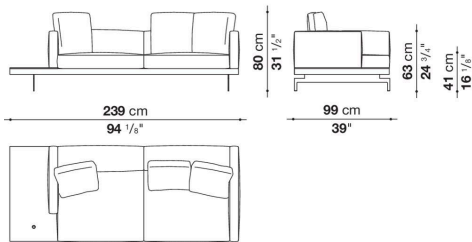

**DAL239D\_1**

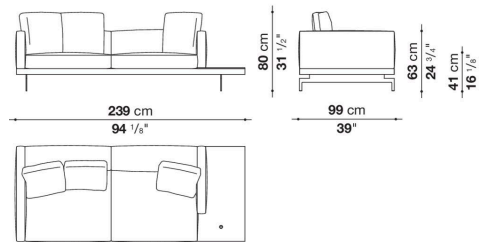

**DAL239S\_2**

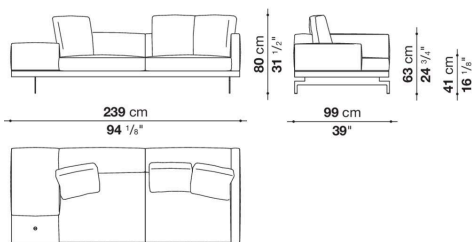

**DAL239D\_2**

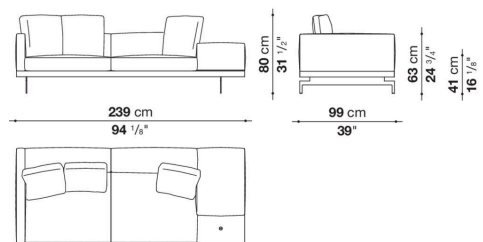

DA280\_1

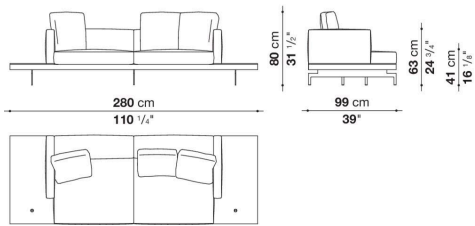

DAL280\_1

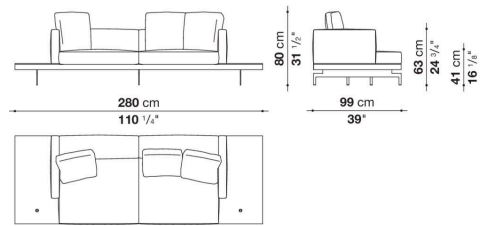

DA280\_2

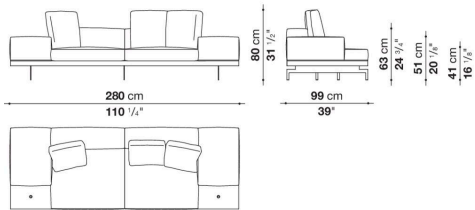

DAL280\_2

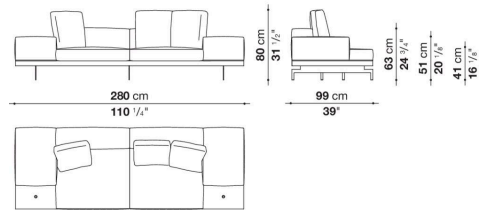

DA280S\_3

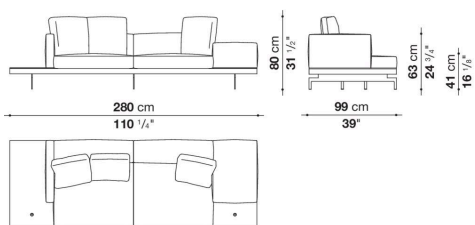

DAL280S\_3

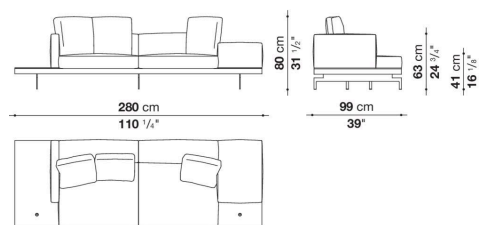

DA280D\_3

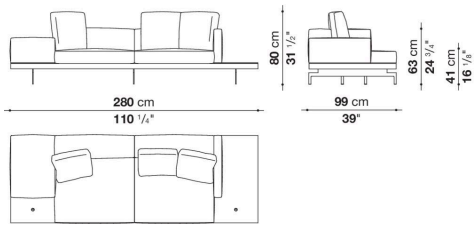

DAL280D\_3

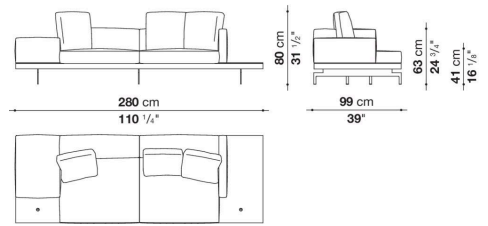

DA288

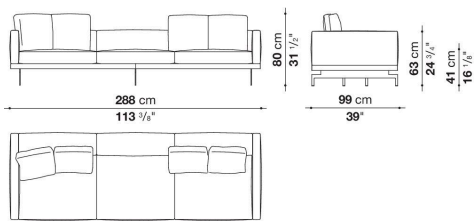

DAL288

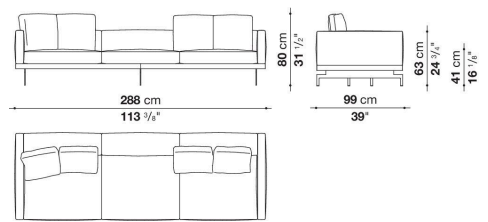

DA239S\_1

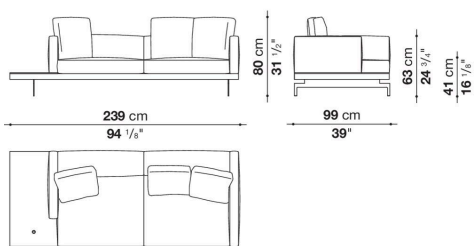

DAL329S\_1

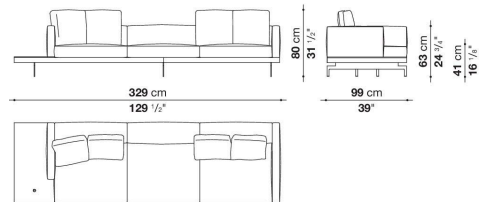

DA239D\_1

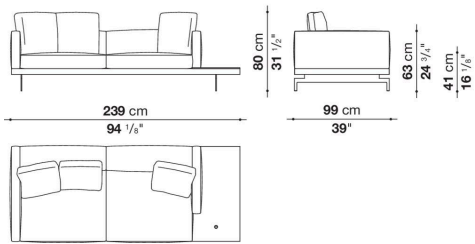

DAL329D\_1

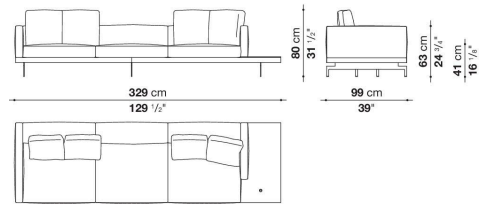

DA239S\_2

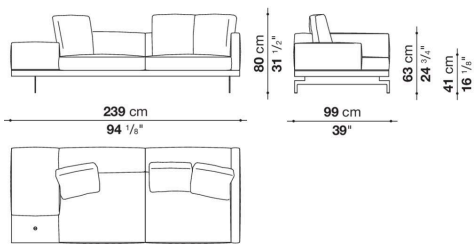

DAL329S\_2

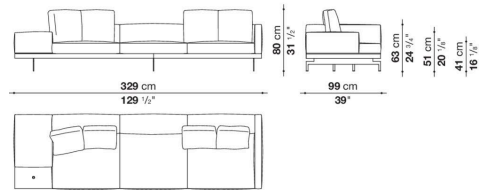

DA239D\_2

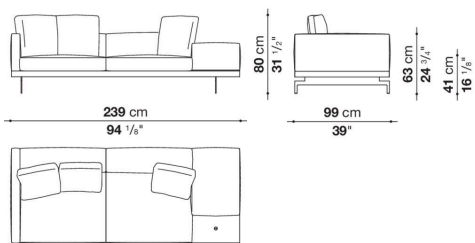

DAL329D\_2

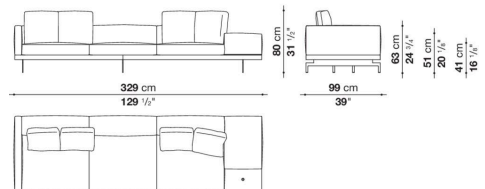

DA370\_1

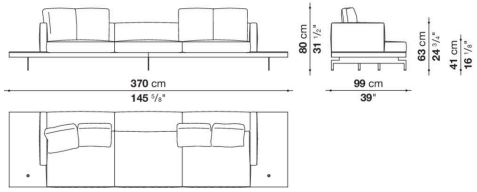

DAL370\_1

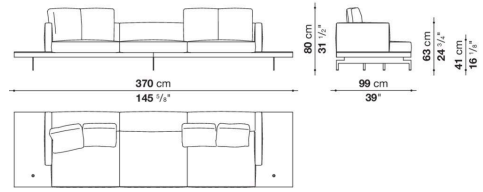

DA370\_2

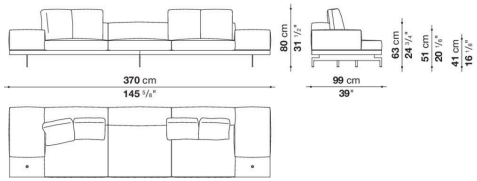

DAL370\_2

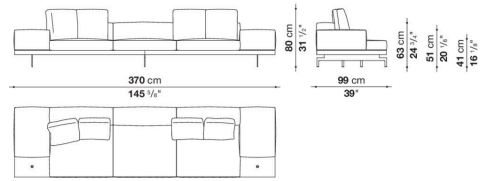

DA370S\_3

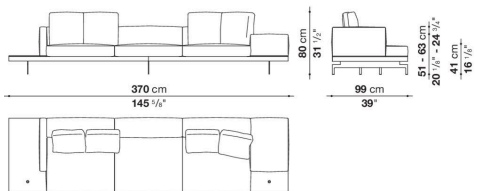

DAL370S\_3

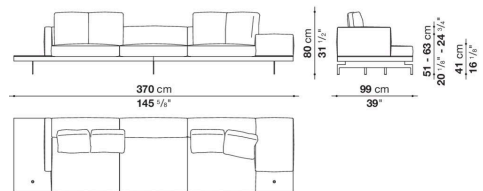

DA370D\_3

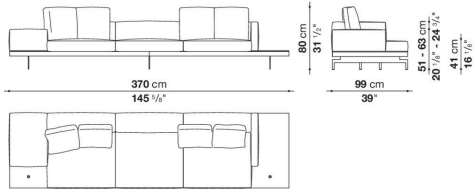

DAL370D\_3

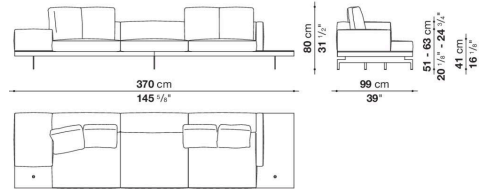

DA189TS

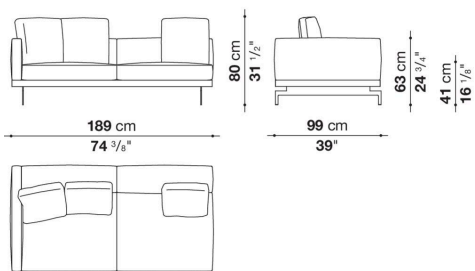

DAL189TS

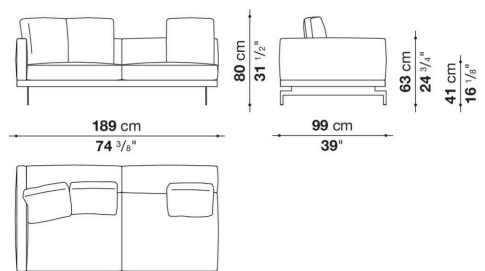

DA189TD

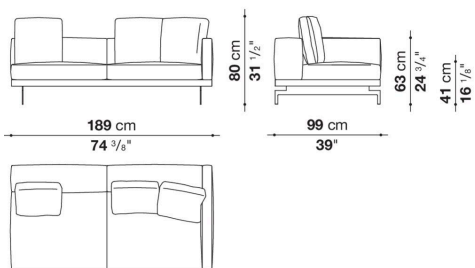

DAL189TD

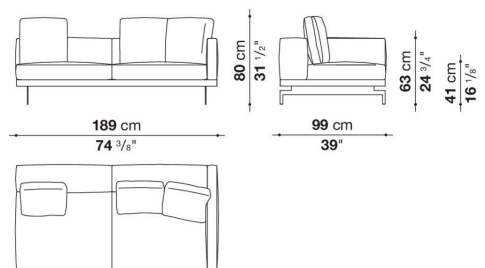

DA230TS\_1

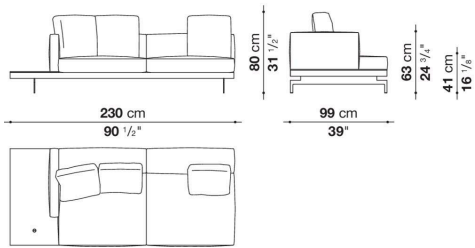

DAL230TS\_1

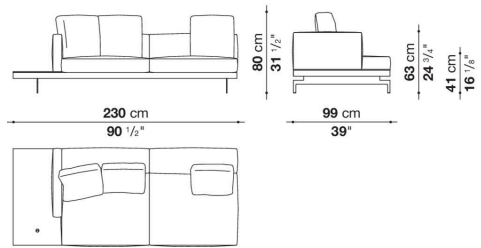

DA230TD\_1

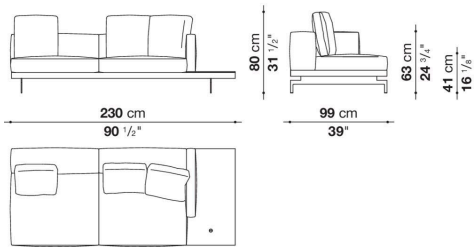

DAL230TD\_1

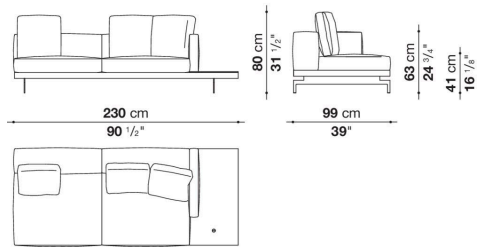

DA230TS\_3

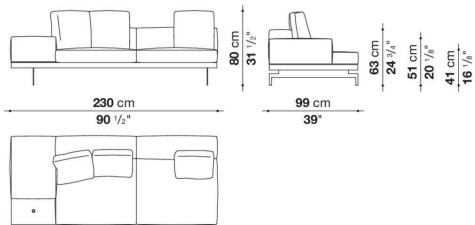

DAL230TS\_3

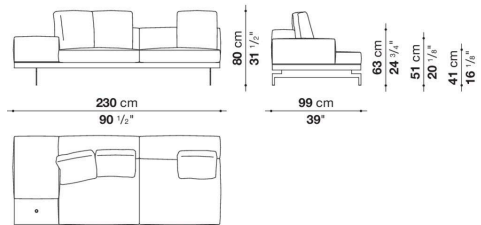

DA230TD\_3

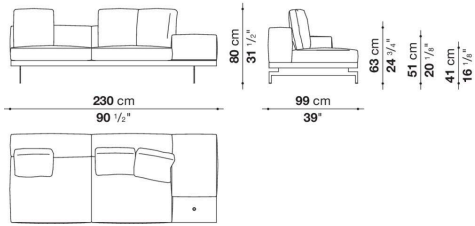

DAL230TD\_3

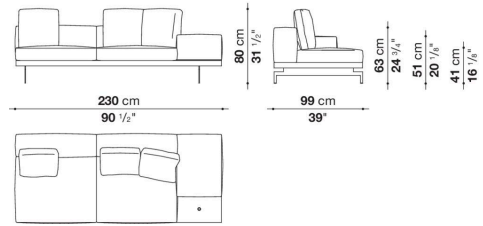

DA320TS\_1

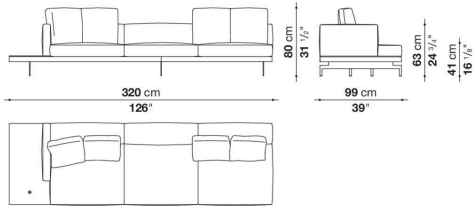

DAL320TS\_1

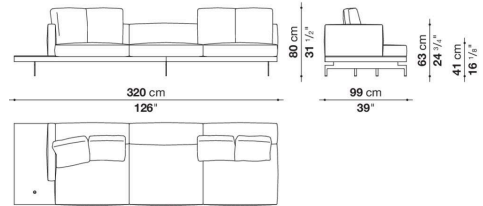

DA320TD\_1

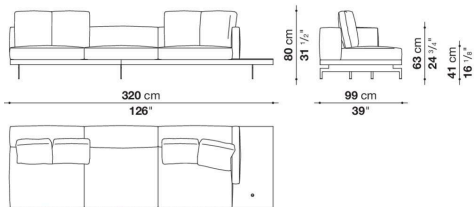

DAL320TD\_1

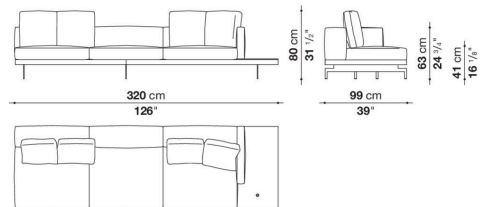

DA320TS\_3

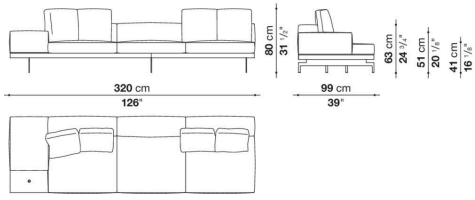

DAL320TS\_3

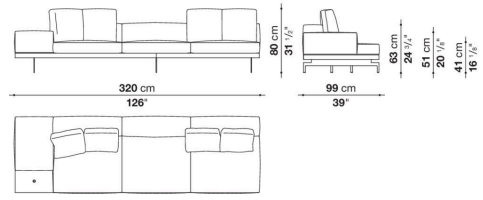

DA320TD\_3

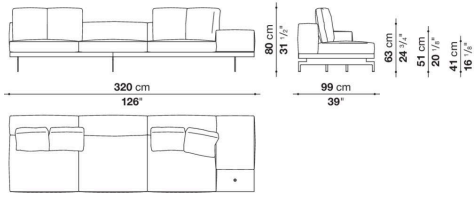

DAL320TD\_3

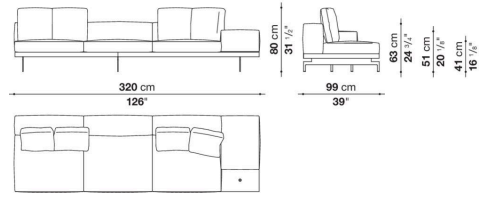

DA279AS\_1

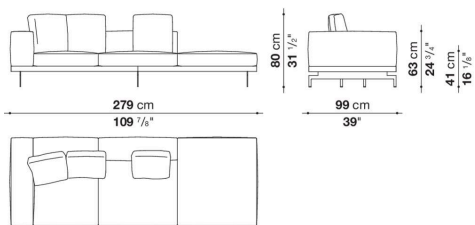

DAL279AS\_1

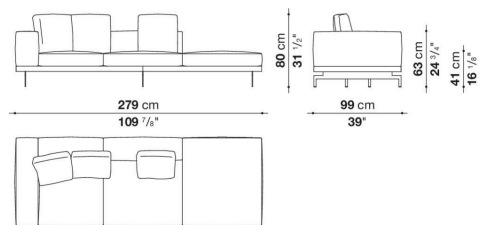

DA279AD\_1

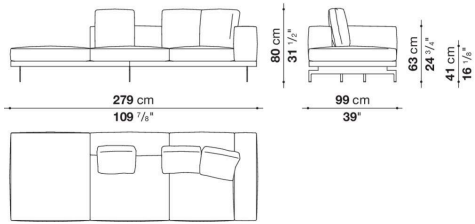

DAL279AD\_1

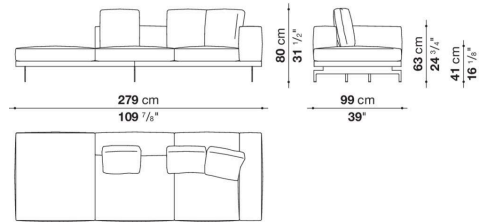

DA288AS

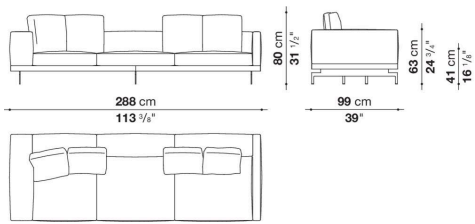

DAL288AS

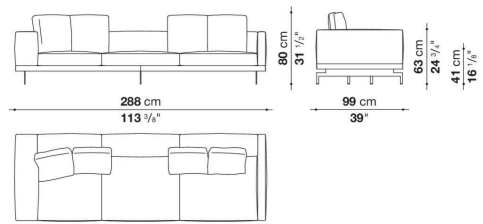

DA288AD

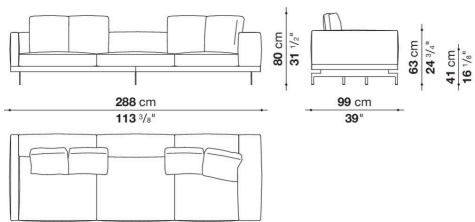

DAL288AD

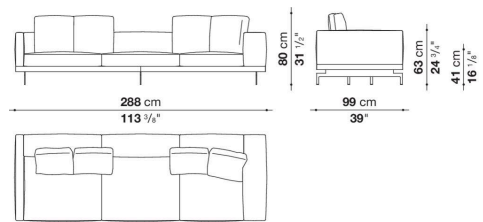

DA288AS\_2

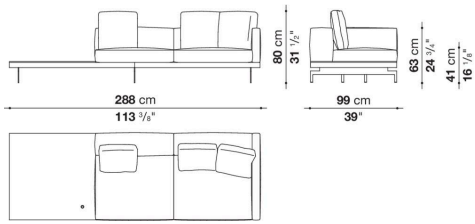

DAL288AS\_2

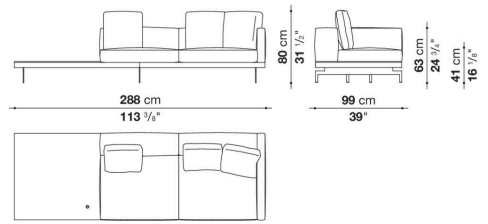

DA288AD\_2

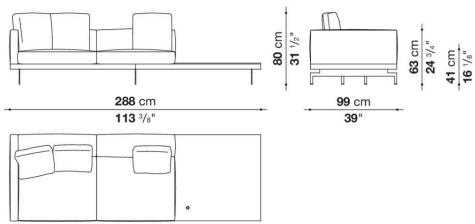

DAL288AD\_2

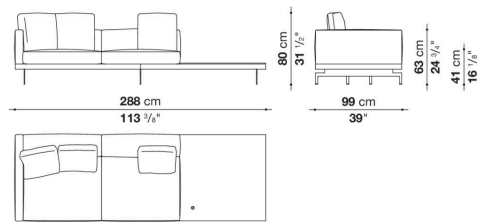

DA329AS\_2

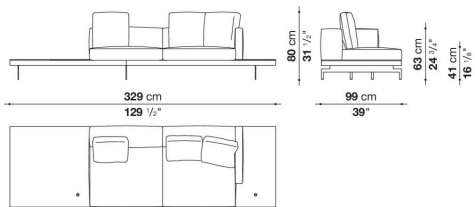

DAL329AS\_2

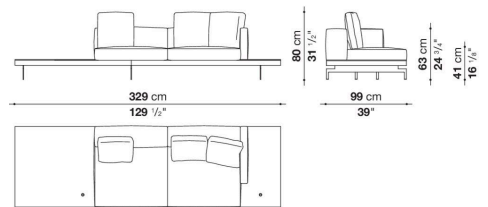

DA329AD\_2

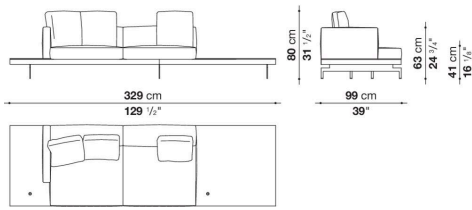

DAL329AD\_2

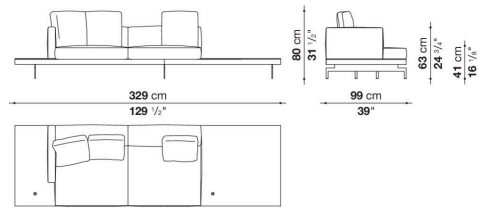

DA329AS\_4

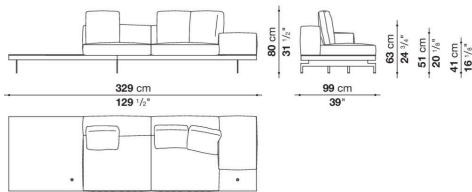

DAL329AS\_4

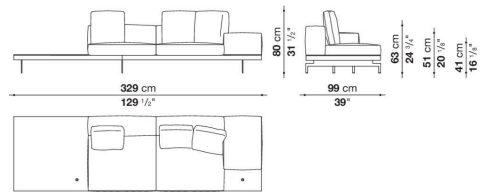

DA329AD\_4

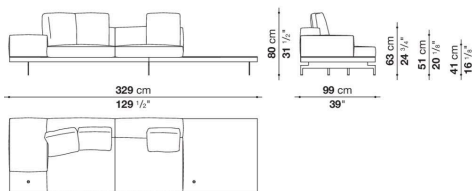

DAL329AD\_4

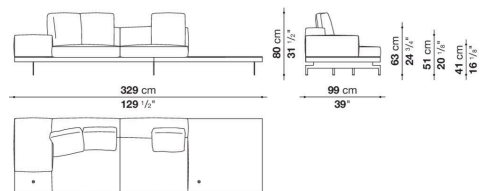

DA150LS\_1

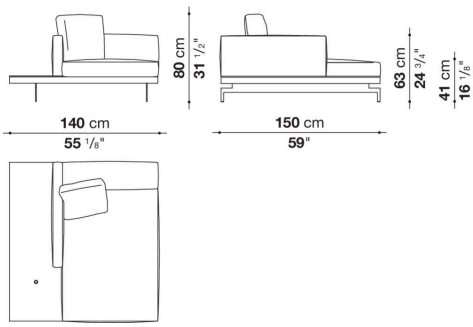

DAL150LS\_1

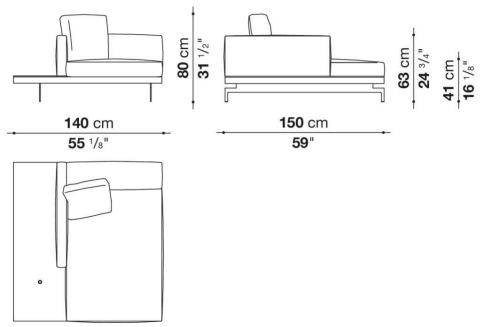

DA150LD\_1

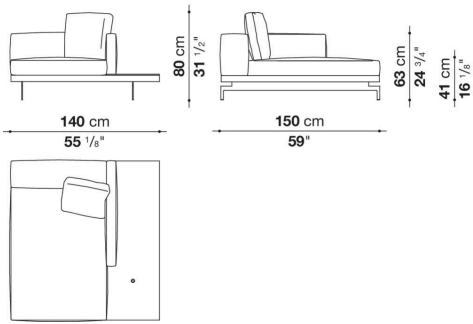

DAL150LD\_1

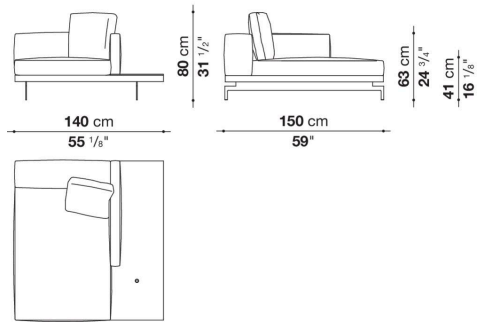

DA150LS\_2

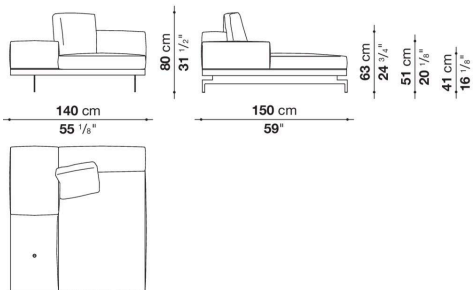

DAL150LS\_2

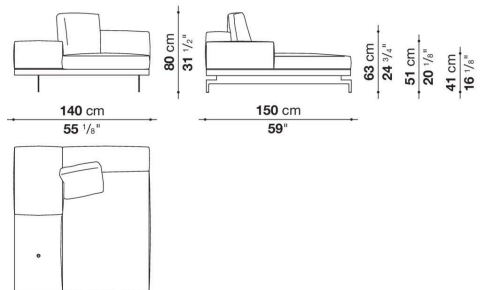

DA150LD\_2

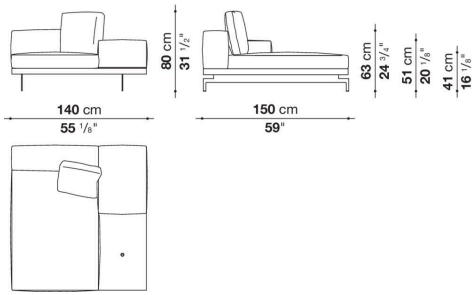

DAL150LD\_2

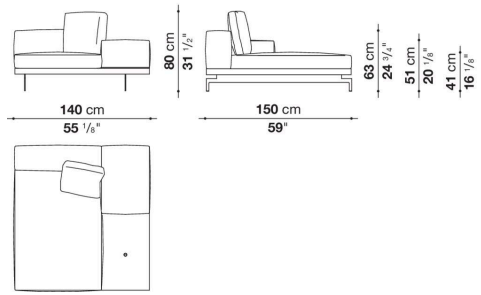

DA280P

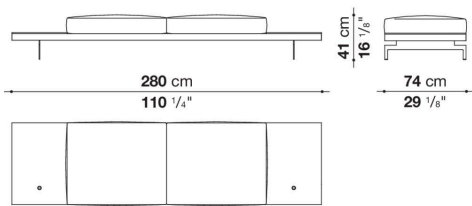

DAL280P

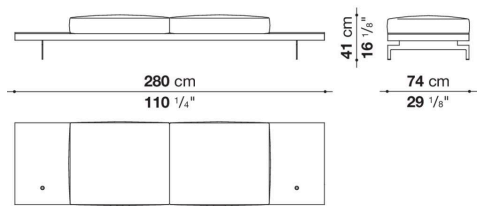

DA320PS\_2

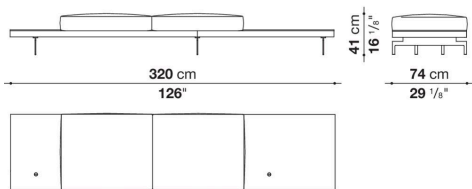

DAL320PS\_2

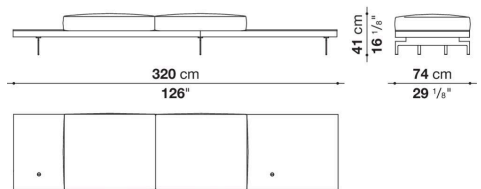

DA320PD\_2

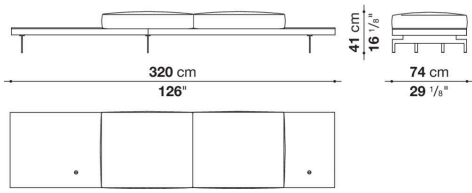

DAL320PD\_2

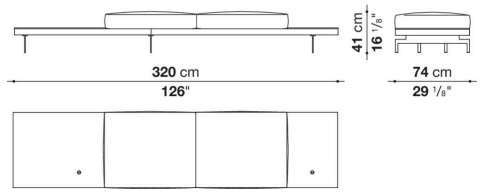

DA370P

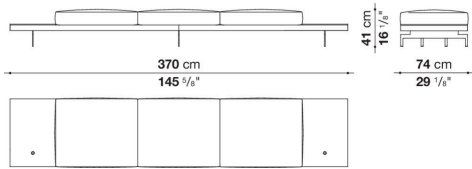

DAL370P

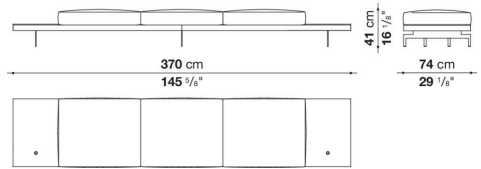

DA370PS

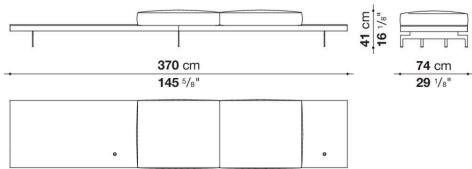

DAL370PS

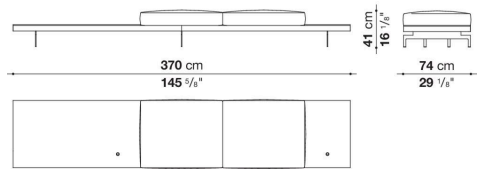

DA370PD

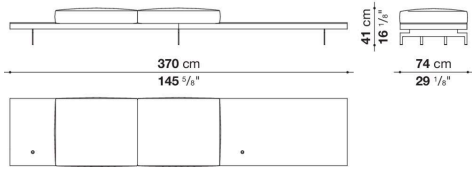

DAL370PD

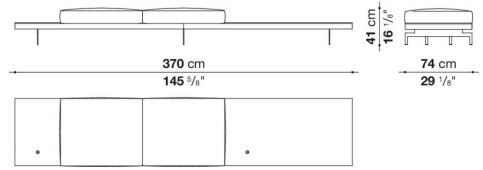

# DA31B

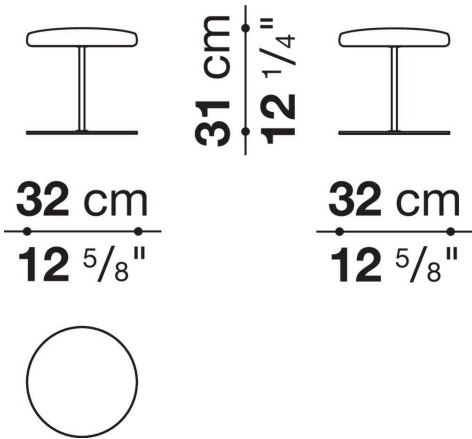

DA329D\_1

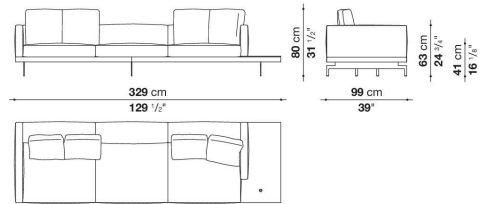

DA329D\_2

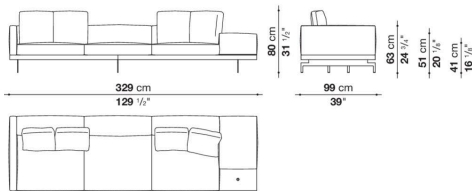

DA329S\_1

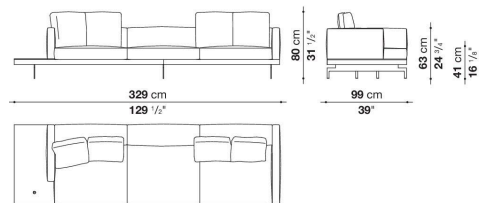

DA329S\_2

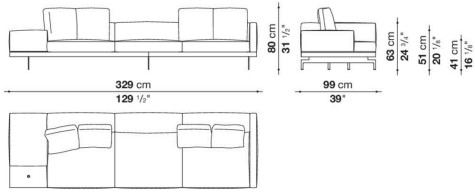

## TDA31

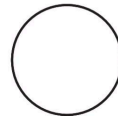
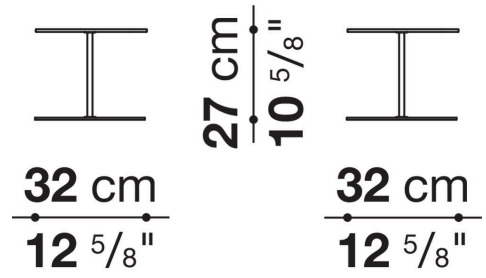

## TD23R

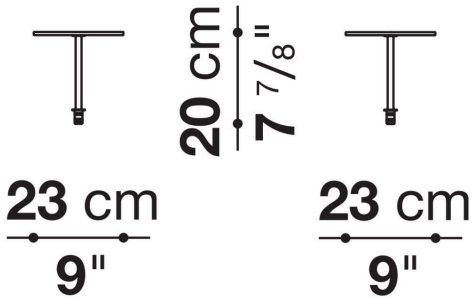

## TD23RL



# TD36

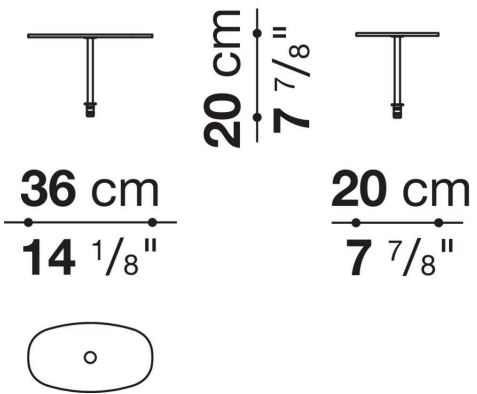

# TD36L

