

# Surface

LIVING STORAGE UNITS

2015

Vincent Van Duysen

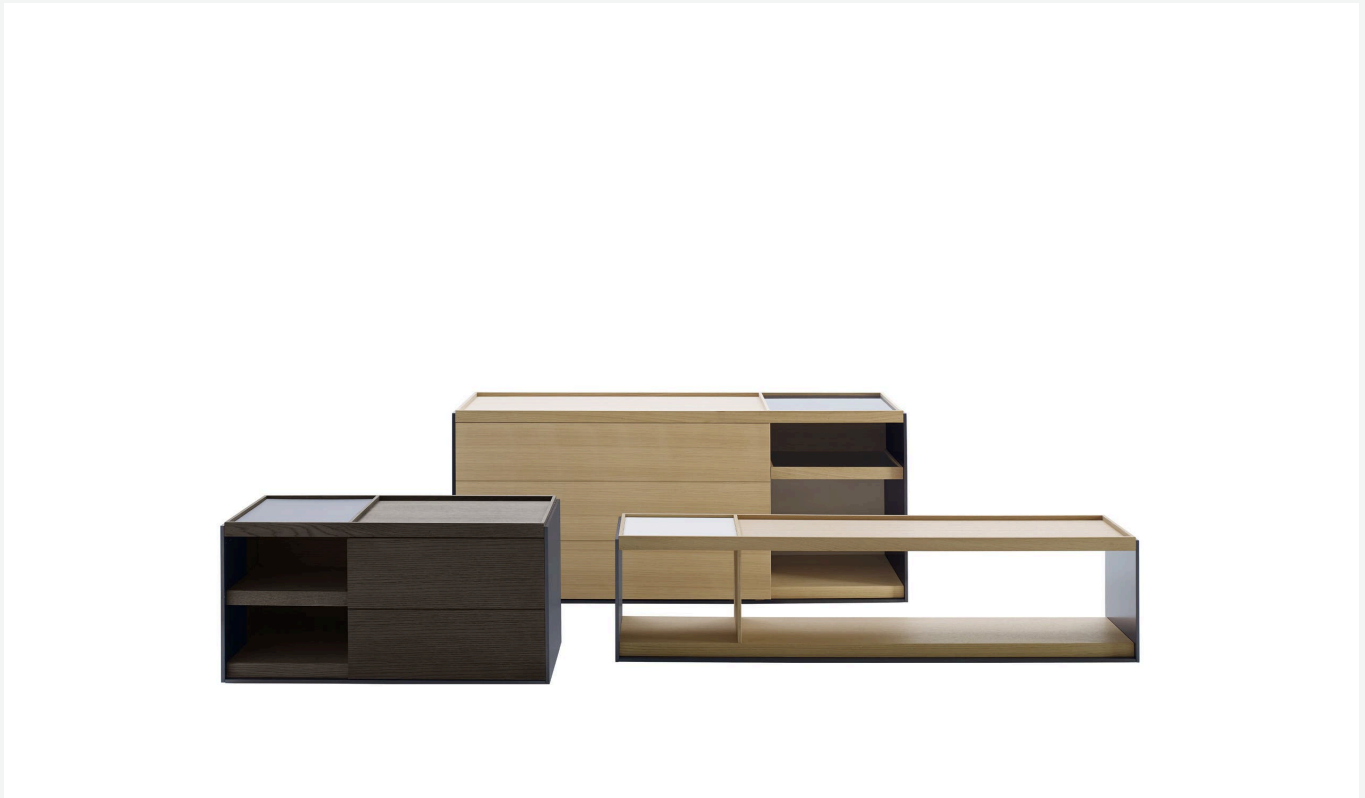

## Description

---

Geometric and linear, the Surface storage units with drawers stand out for their reduced forms, essential materials and colour choices – sober features that never issue from simplification, but rather from a subtle quest for balance. With their vast customisation possibilities and combination of materials, they are truly iconic pieces of modern furniture.

## Technical information

---

**Storage unit frame**

veneered wood particles panel

**Storage unit frame with section and extractable shelf**

solid wood, veneered wood particles panel

**Section and drawer front**

MDF wood fibre panel

**Side and baseboard**

HPL stratified laminate panel

**Drawer frame**

panels in MDF wood fibre, bottom in refined wood particles

**Adjustable feet**

steel and plastic material

# Technical drawings

**CSF75**

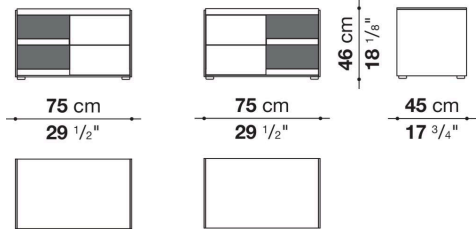

**CSF75V**

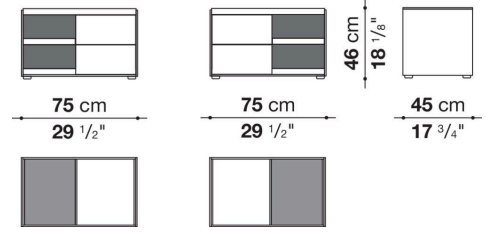

**CSF75A**

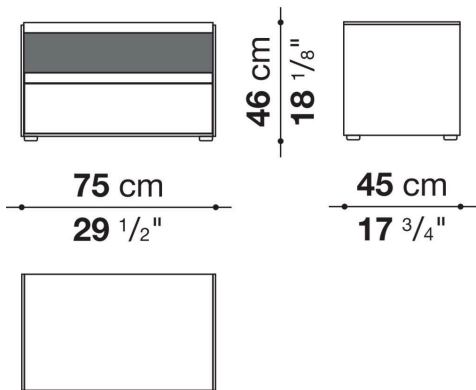

**CSF75AV**

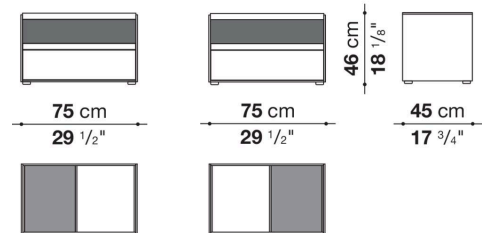

**CSF90**

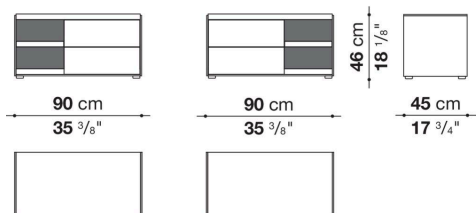

**CSF90V**

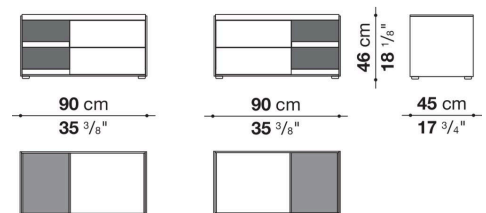

### CSF90A

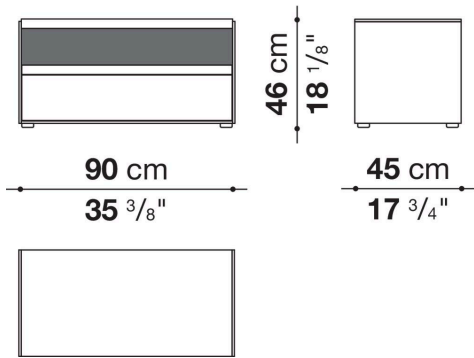

### CSF90AV

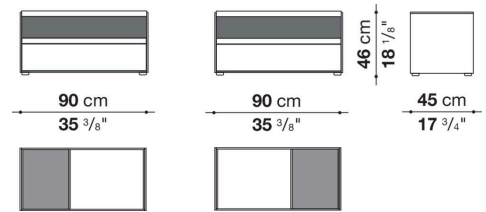

### CSF120A

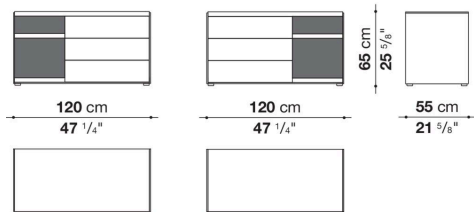

### CSF120AV

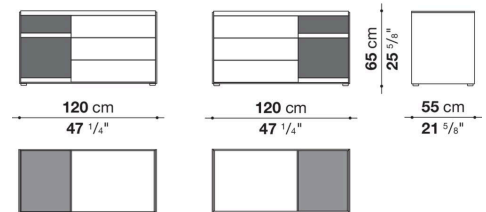

### CSF120BV

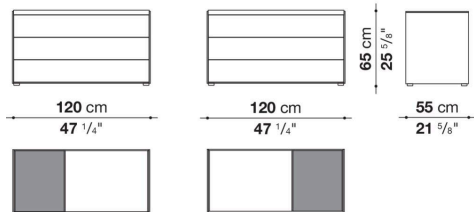

### CSF150D

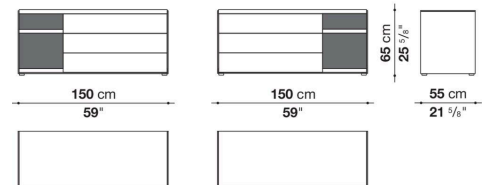

**CSF150DV**

