

Erica '25

SOFAS

2025

Antonio Citterio



Description

The Erica '25 series of outdoor sofas stands out for its lightness and refined design that make it ideal for both public and residential settings, delivering ergonomic comfort together with strength for outdoor use. The proposal comprises linear sofas in different sizes and depths, sofas featuring a slightly curved design ideal for creating dynamic and convivial solutions for outdoor relaxation, a dormeuse also characterized by a curved design, a day bed with particularly generous proportions equipped with a high back and integrated headrest. Common elements to the entire series are the powder-coated die cast aluminium frames which offer lightness and durability, the interlacing made of polypropylene ribbons designed for outdoor use, and the foot design which provides a sense of visual and formal continuity. The seat cushions upholstery, embellished with a decorative profile, grants an appearance of natural softness making them particularly inviting. The refined shades of the frame and interlacing are complemented by a vast range of cushion covers, in an array of tones and designs, all co ordinating with each other.

Technical information

Frame

die-cast aluminium and extrusions with polyester powder painting

Back upholstery

polyester fiber recycled from PET, cover in water repellent polyester fibre

Seat upholstery

shaped polyurethane, polyester fiber recycled from PET, cover in water repellent polyester fibre

Seat webbing

polypropylene fibre and synthetic rubber threads

Interlacing

polypropylene fibre braid

Ferrules

thermoplastic material

Waterproof cover cloth

PES fabric coated on one side in PU

Cover

fabric in limited categories (with profile)

Technical drawings

ER155A

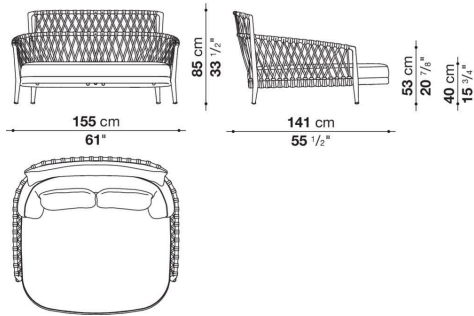

7ER170

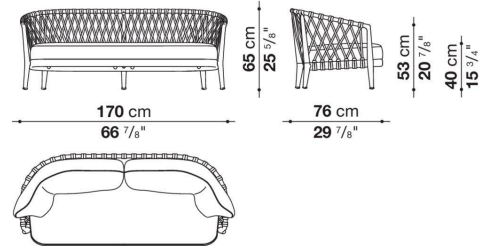

8ER170

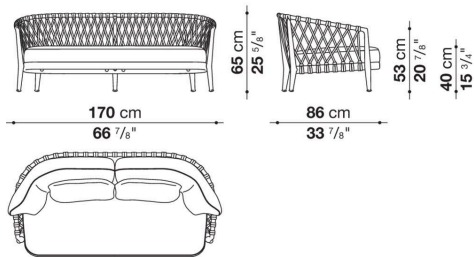

9ER170

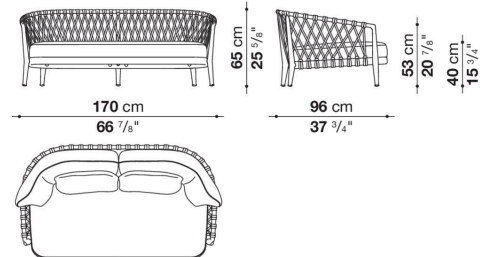

7ER216

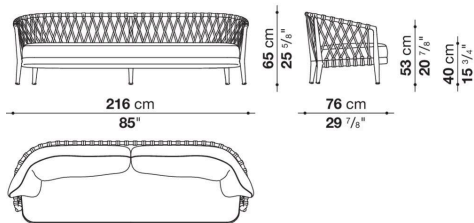

8ER216

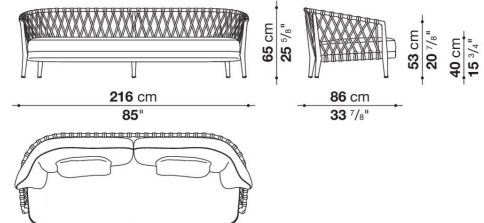

9ER216

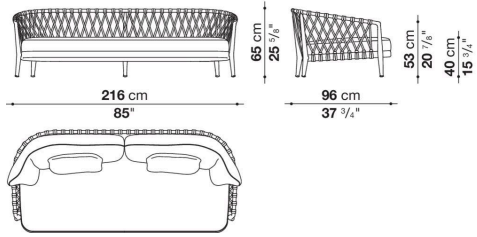

9ER244C

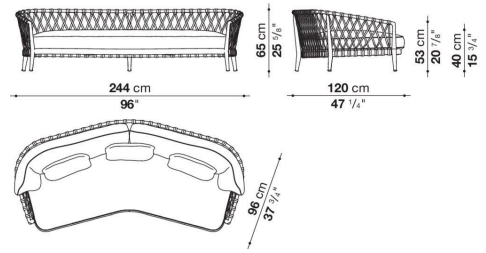

9ER240CS

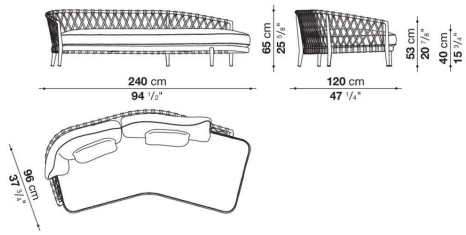

9ER240CD

