

Andy '13

SOFAS

2013

Paolo Piva



Description

Formal rigour, calibrated proportions and soft geometry characterize Andy '13, a sofa equipped with a mechanism that allows the backrest to change its inclination from a horizontal position, more decorative and with a contemporary sign, to a vertical one for more comfortable sitting. It is available in linear and corner versions with chaise longue, with fabric or leather upholstery.

Technical information

Innenrahmen

Stahlrohre und -profile

Innenrahmen Füllung

kalt elastischer Polyurethanschaum Bayfit®, Futter aus Polyesterfaser

Rückenkissen mit Roller (AD60CP)

Daunen, Polyurethaneinsatz und Polyesterfaser, Typ mit Umrandung und Roller

Gestell

Stahl und Stahlprofile

Profilen

Stahlrohre

Pfosten

Stahlblech

Füße und Gleiter

Material thermoplastisch

Bezug

Stoff (Profilen aus Kunstleder) oder Leder

Technical drawings

AD248

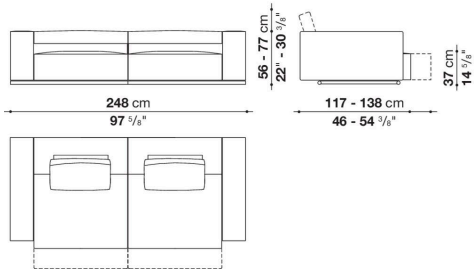

AD292

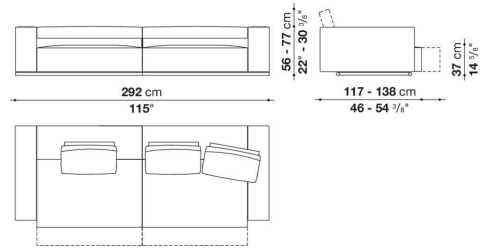

AD346

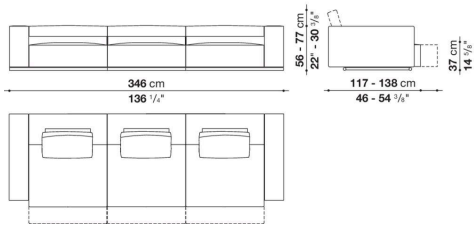

AD412

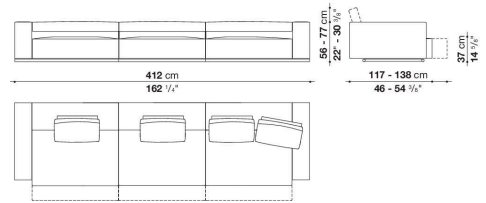

AD326AS

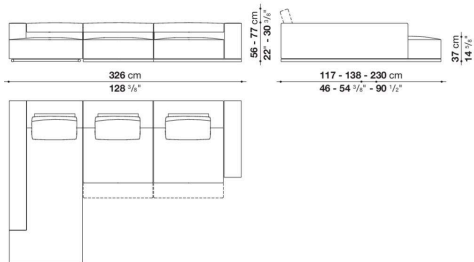

AD326AD

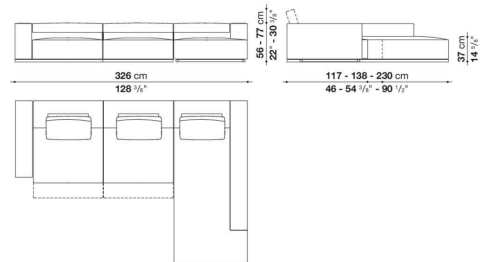

AD370AS

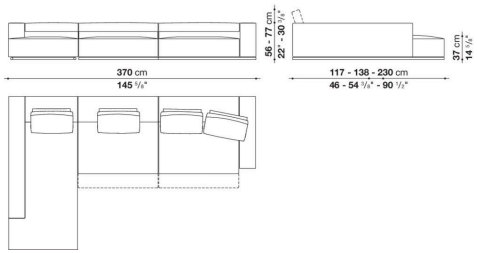

AD370AD

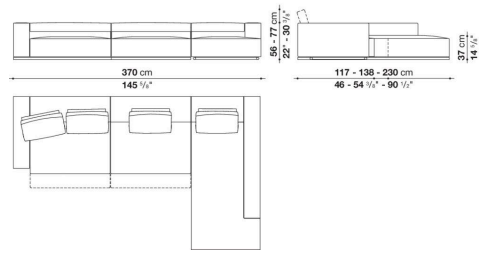

AD253S

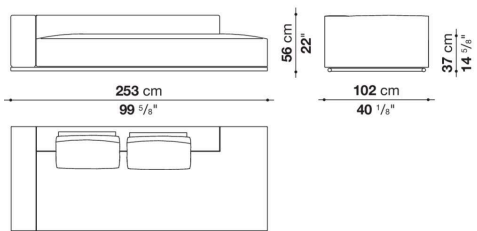

AD253D

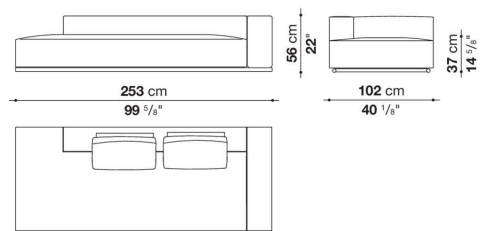

AD98P

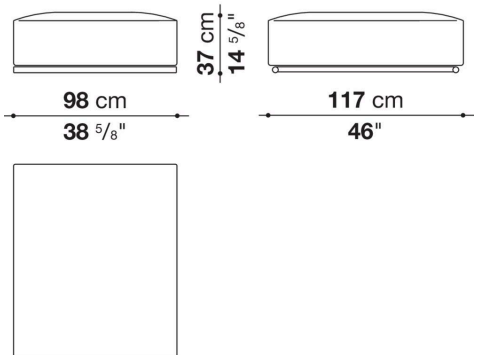

AD120P

