

Husk

ARMCHAIRS

2011

Patricia Urquiola



Description

Comfort and eco-sustainability are the key words for describing the Husk chairs. A collection that is a tribute to softness and an invitation to relax thanks to the generous extra soft cushions with a capitonné design. The hard shell, available in different colours, is made of Hirek®, a special plastic material made up of recycled and recyclable polymers. The cushions come in three versions, with larger sizes on the seat or on the back, or with headrest. The series is completed by the coordinated footrest that makes Husk armchair perfect for every need.

Technical information

Schale

Kunststoff Hirek®

Schale Füllung

Polyesterfaser, Futter aus Baumwolle

Stützelement der Sitzkissen

geformtes Polyurethan, rutschfeste Stoff

Drehbares Untergestell (H1G-H2G-H3G-H4G)

Aluminiumguss, Stahlprofile, hartem Polyurethan oder Massivholz

Untergestell (HP4)

Stahlprofile, hartem Polyurethan oder Massivholz

Untergestell (H1M-H2M-H3M-H4M-HP4M)

Aluminiumguss und -Profile

Gleiter

Kunststoff

Bezug

Stoff oder Leder

Technical drawings

H1G

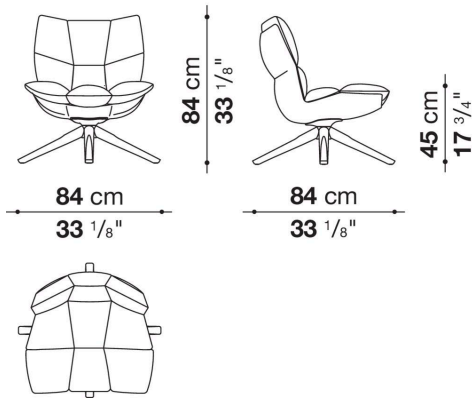

H2G

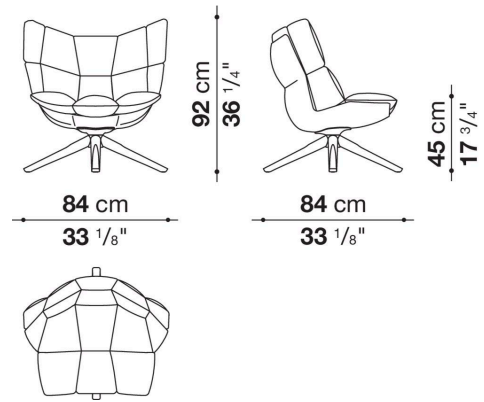

H3G

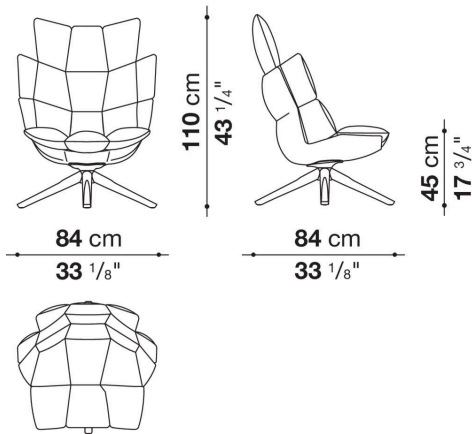

H4G

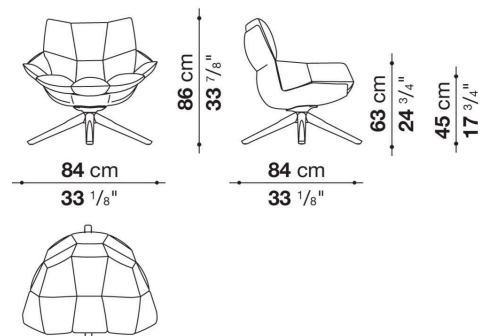

HP4

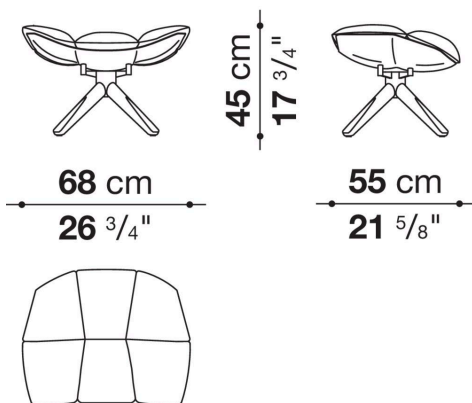

H1M

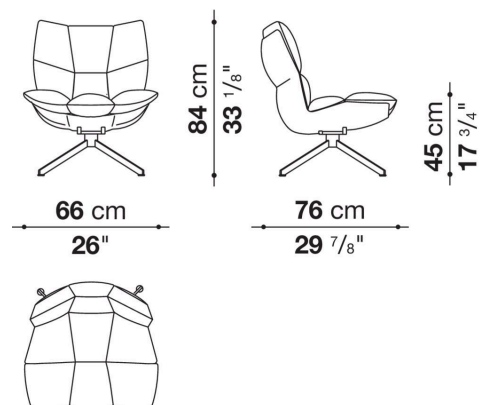

H2M

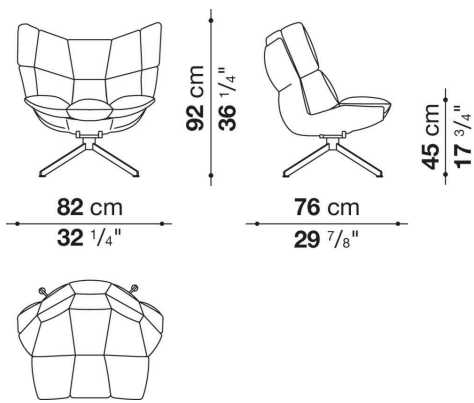

H3M

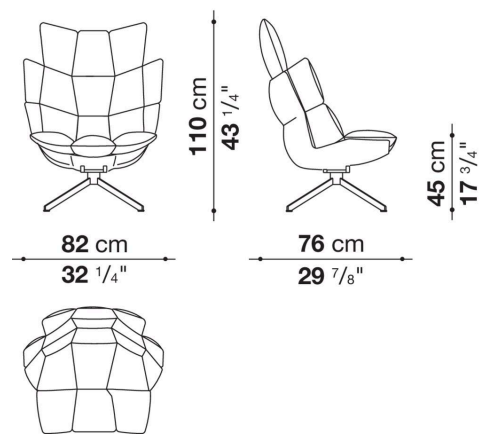

H4M

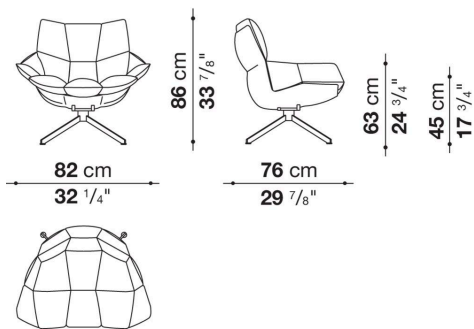

HP4M

