Dock

SOFAS

2019

Piero Lissoni



Description

In the version with a 41 cm seat height, Dock is a collection of upholstered elements with a multiple soul, rendered highly flexible by the countless configurations made possible by the numerous elements included in the collection. This horizontally-spanning project is underscored by a highly textured platform: a dynamic element that extends beyond the sides of the sofa to create a support surface. The slender armrests, available in two depths, are generously padded, just like the backrest. The cushions create a play of sizes and proportions, making it possible to put together double-sided, corner and chaise longue compositions, with or without backrests, suitable for use at the centre of the room or for more traditional solutions. Dock comes with a series of accessories offering a vast array of possibilities: it is possible to insert extra elements between the seat cushions, such as comfortable padded armrests, while functional and supporting elements can be placed on the platform, ensuring further customisation possibilities so as to experience and design the system at will. The base frame is in steel. The body is upholstered in either fabric or leather. Dock also comes in a low version virtually flush with the ground. The height of the feet from ground is 16,5 cm (6 1/2").

Technical information

Sitz Innenrahmen (bezogene Basis)

Stahlrohre und -profile, Paneel aus Schichtholz, Futter aus Polyesterfaser

Sitz Innenrahmen (Holzbasis)

Stahlrohre und -profile, Paneel aus Schichtholz furniert, Massivholz

Rückenlehne und Armlehne Innenrahmen

Stahlrohre und -profile

Sitzkissen Füllung

geformtes Polyurethan verschiedener Dichten, sterilisierte Daunen, Futter aus Polyesterfaser

Rückenkissen Füllung

sterilisierte Daunen, Futter aus Polyesterfaser

Platte

Paneel aus MDF Holzfaser furniert

Stopper

Stahl

Traggestell

Stahlprofile

Stützelement der Armlehne (DA31B)

Aluminium und Stahl

Platte der Armlehne (DA31B)

Massivholz, geformtes Polyurethan verschiedener Dichten, Futter aus Polyesterfaser

Beistelltischträger

Stahl

Beistelltischplatte

Massivholz oder Glas

Gleiter

Kunststoff

Bezug

Stoff (Canneté Profil) oder Leder

Technical drawings

DA198

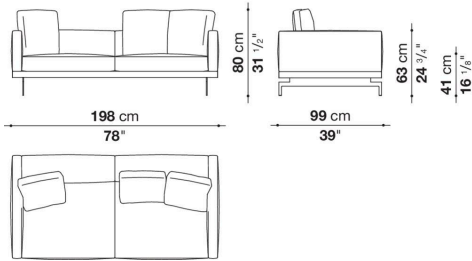

DAL198

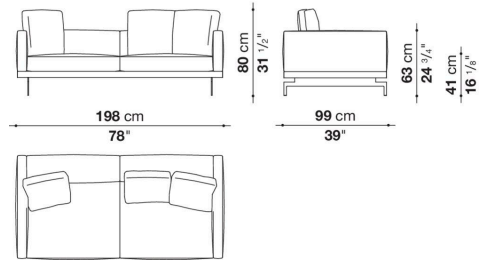

DAL239S_1

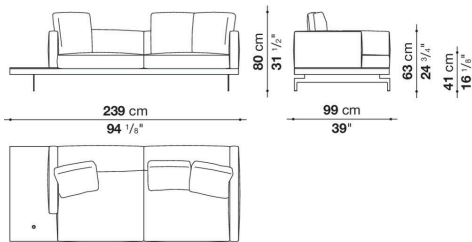

DAL239D_1

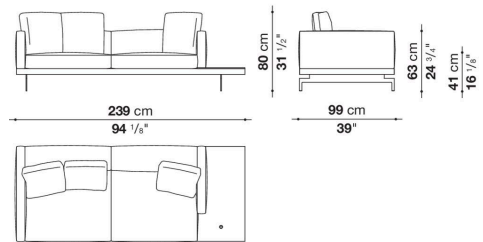

DAL239S_2

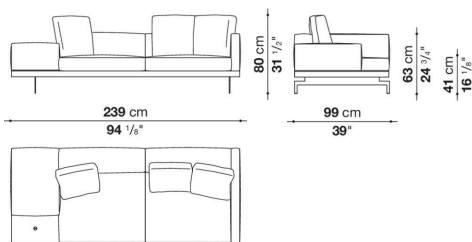

DAL239D_2

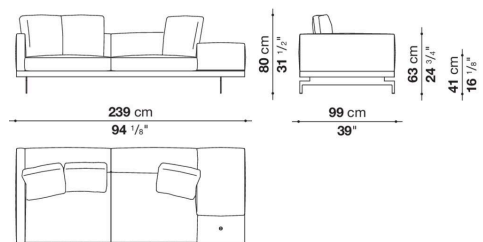

DA280_1

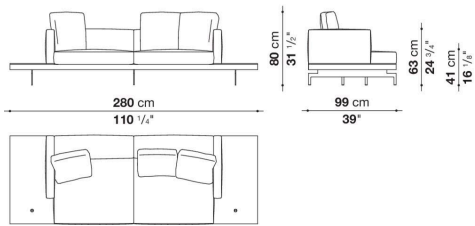

DAL280_1

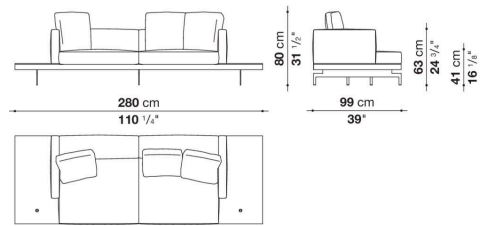

DA280_2

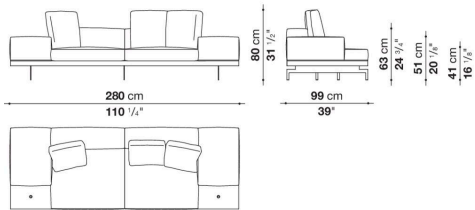

DAL280_2

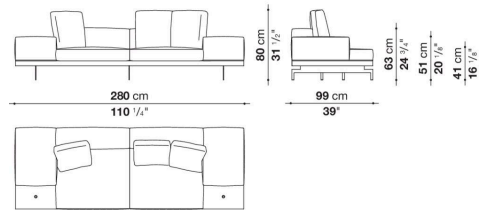

DA280S_3

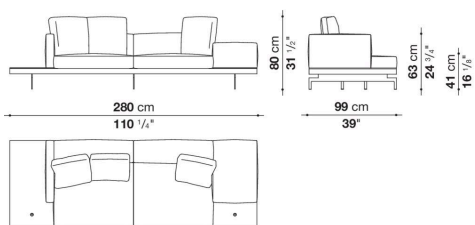

DAL280S_3

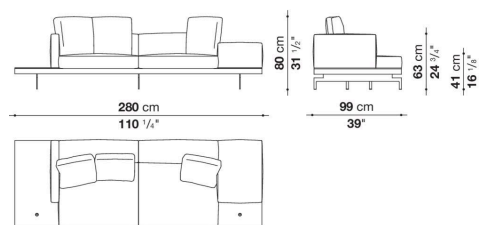

DA280D_3

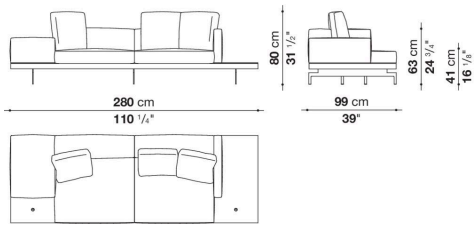

DAL280D_3

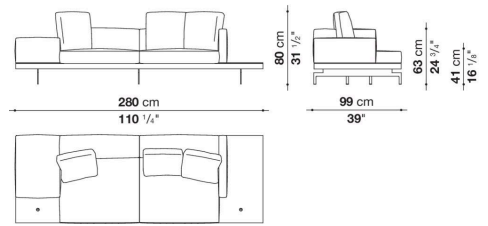

DA288

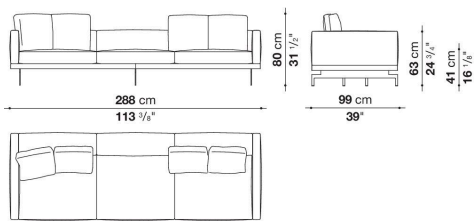

DAL288

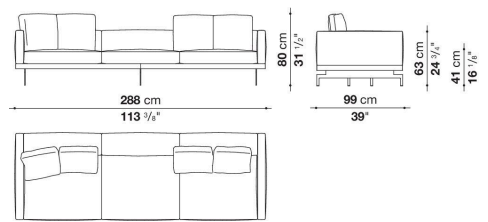

DA239S_1

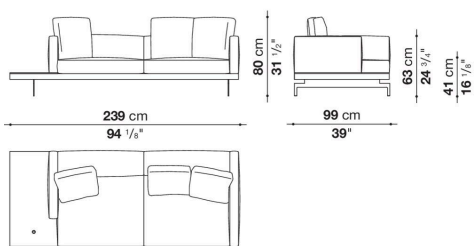

DAL329S_1

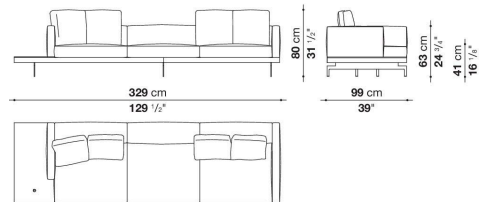

DA239D_1

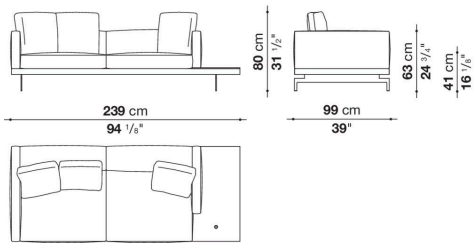

DAL329D_1

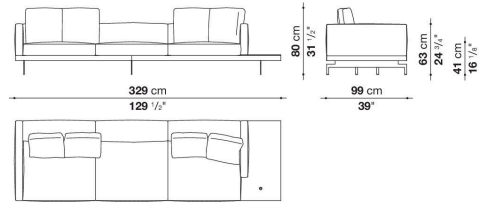

DA239S_2

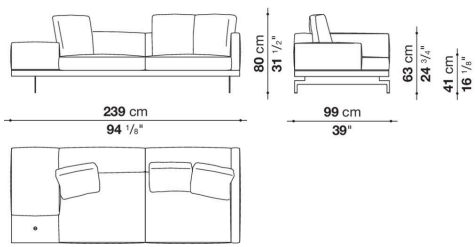

DAL329S_2

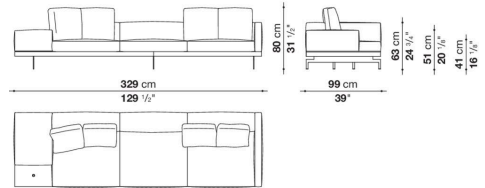

DA239D_2

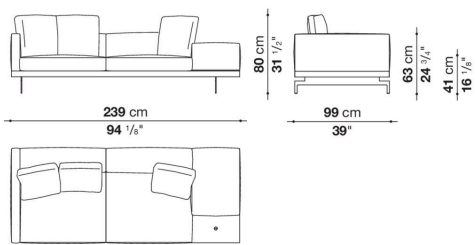

DAL329D_2

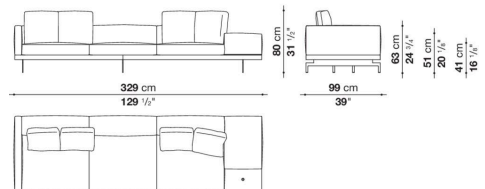

DA370_1

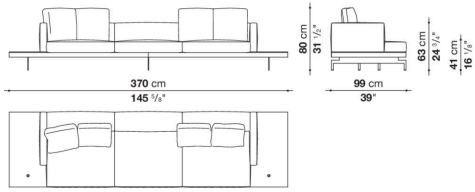

DAL370_1

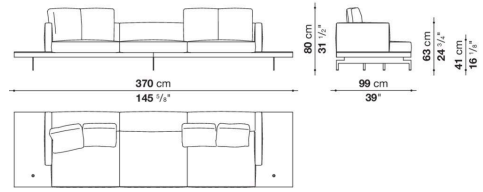

DA370_2

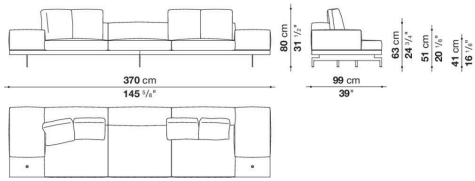

DAL370_2

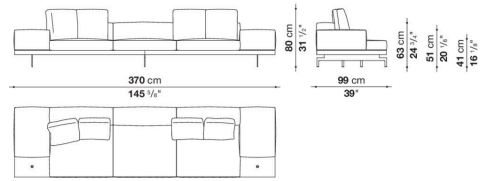

DA370S_3

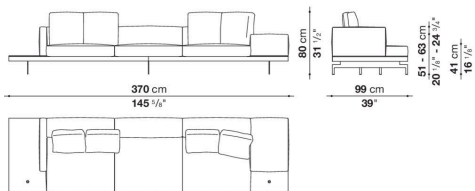

DAL370S_3

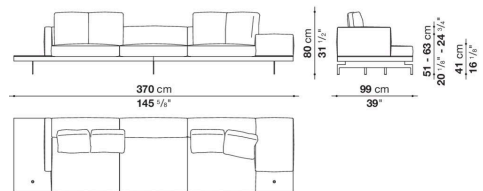

DA370D_3

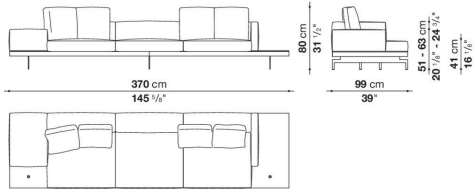

DAL370D_3

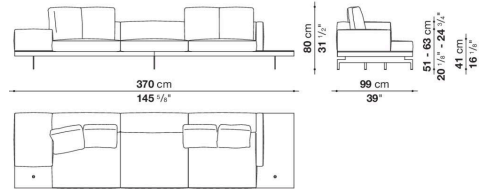

DA189TS

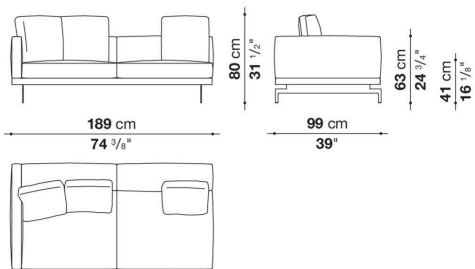

DAL189TS

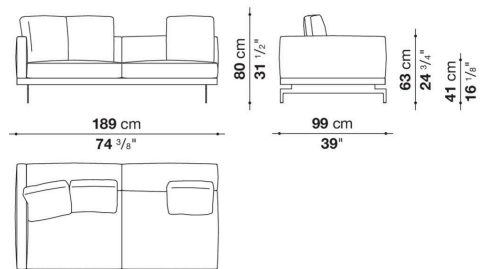

DA189TD

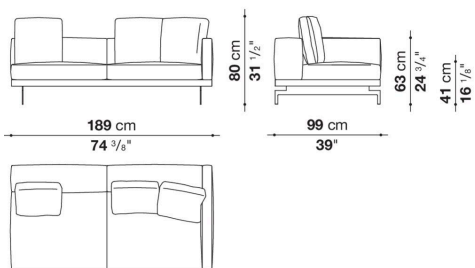

DAL189TD

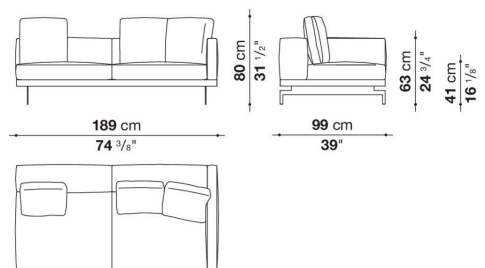

DA230TS_1

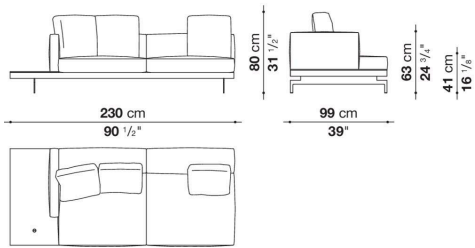

DAL230TS_1

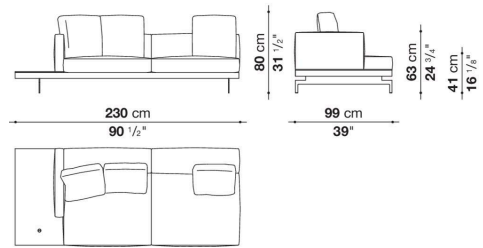

DA230TD_1

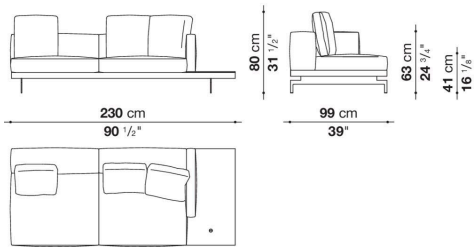

DAL230TD_1

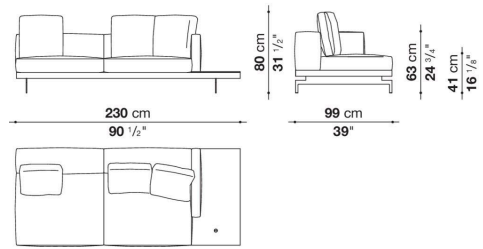

DA230TS_3

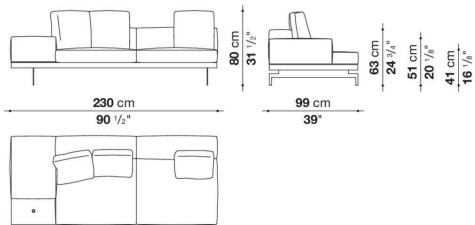

DAL230TS_3

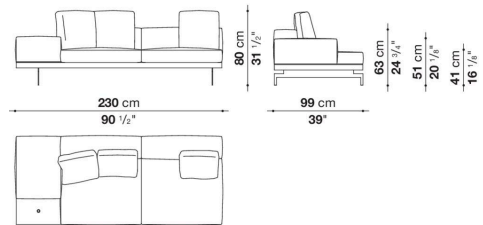

DA230TD_3

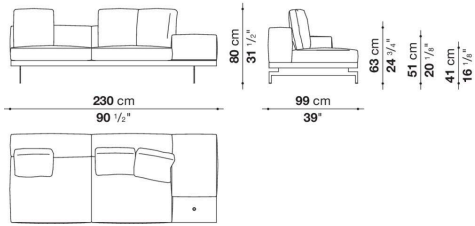

DAL230TD_3

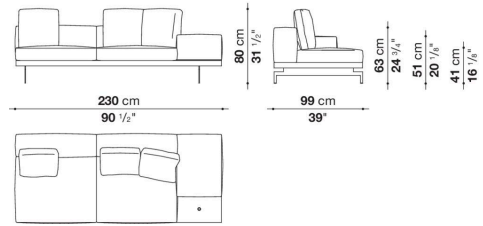

DA320TS_1

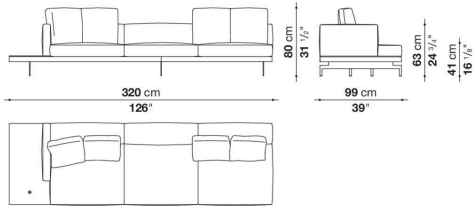

DAL320TS_1

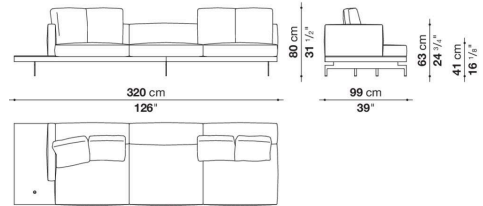

DA320TD_1

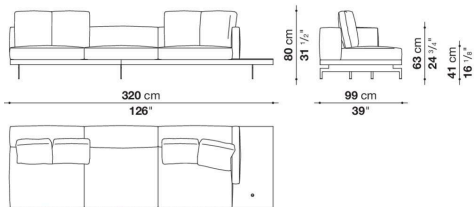

DAL320TD_1

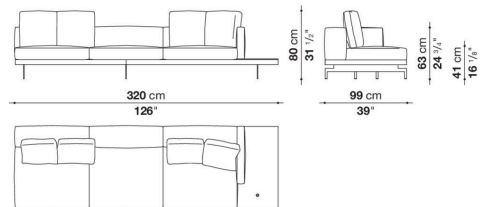

DA320TS_3

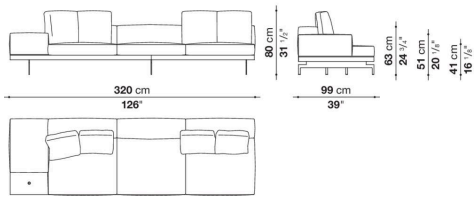

DAL320TS_3

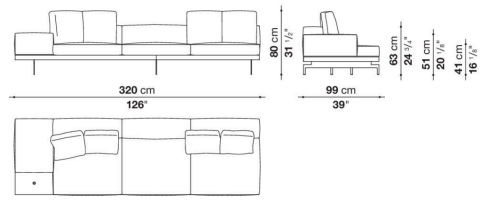

DA320TD_3

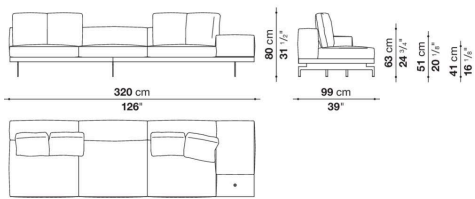

DAL320TD_3

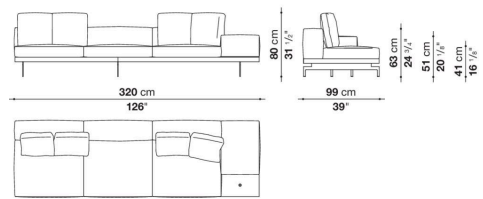

DA279AS_1

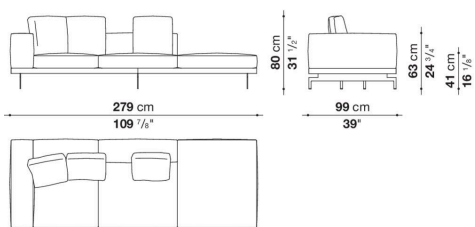

DAL279AS_1

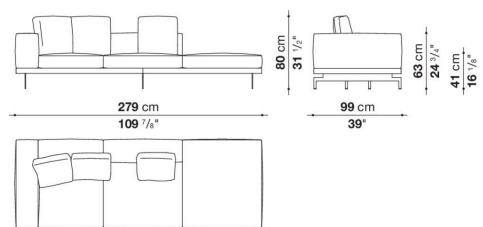

DA279AD_1

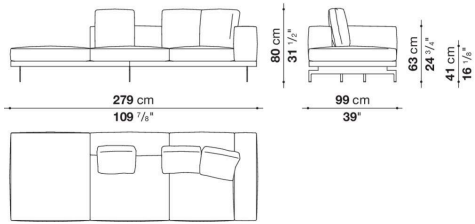

DAL279AD_1

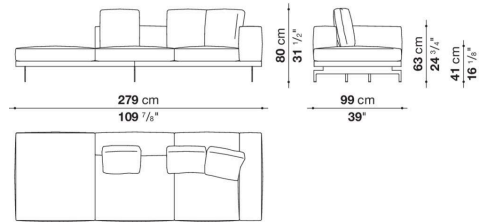

DA288AS

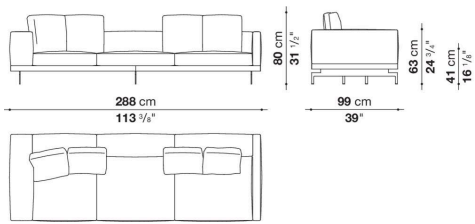

DAL288AS

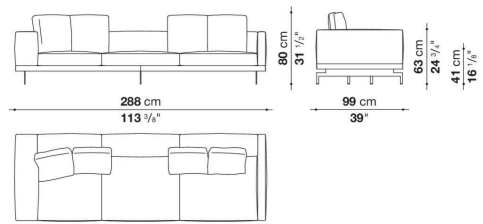

DA288AD

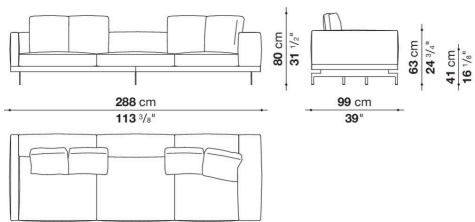

DAL288AD

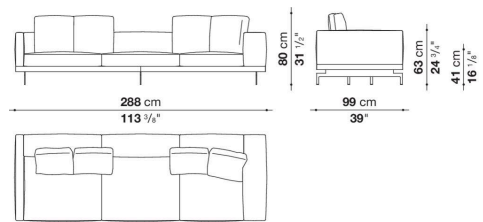

DA288AS_2

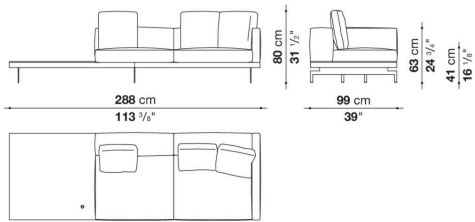

DAL288AS_2

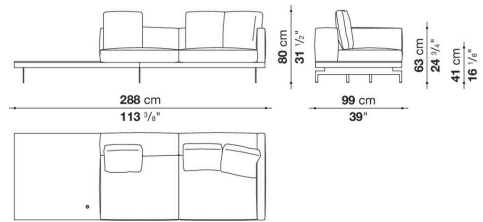

DA288AD_2

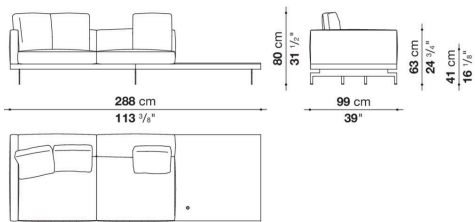

DAL288AD_2

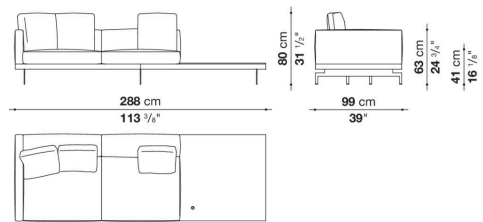

DA329AS_2

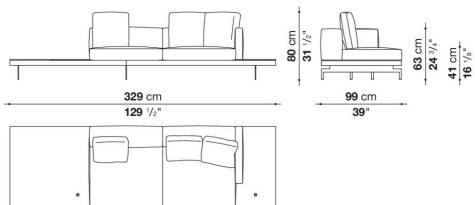

DAL329AS_2

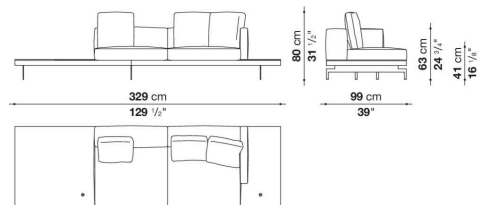

DA329AD_2

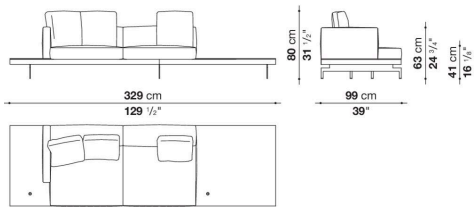

DAL329AD_2

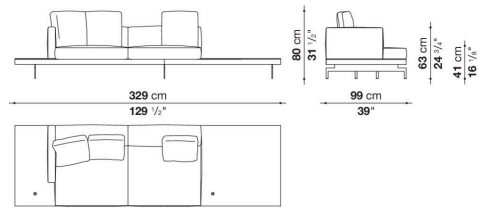

DA329AS_4

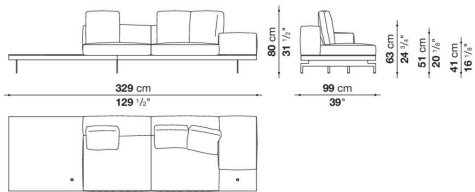

DAL329AS_4

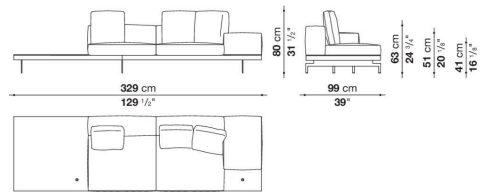

DA329AD_4

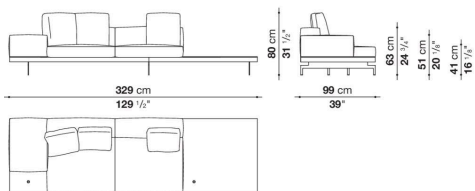

DAL329AD_4

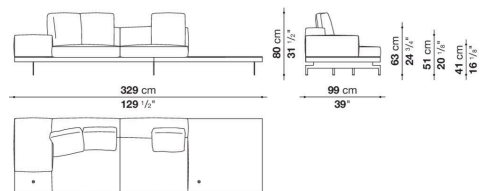

DA150LS_1

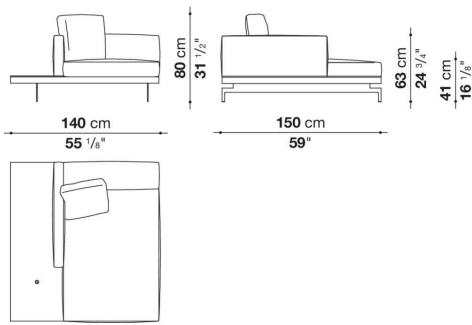

DAL150LS_1

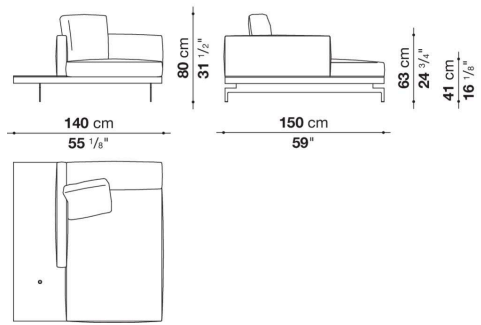

DA150LD_1

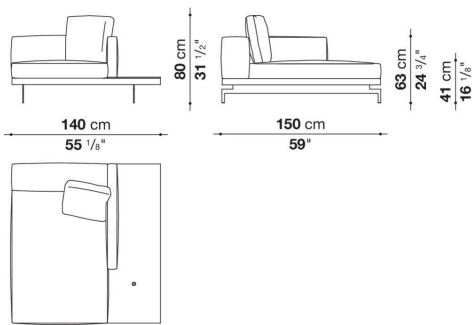

DAL150LD_1

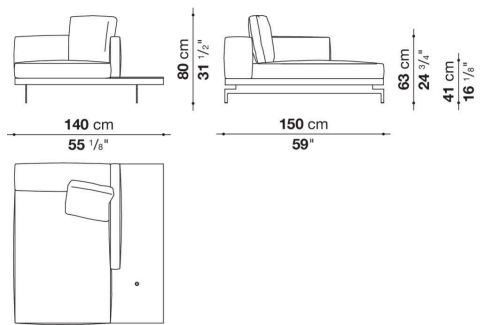

DA150LS_2

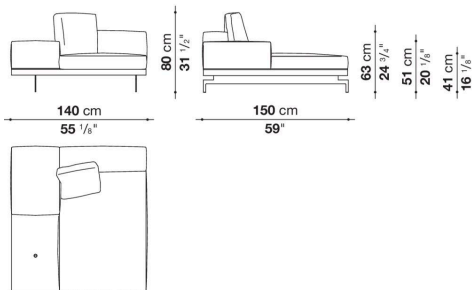

DAL150LS_2

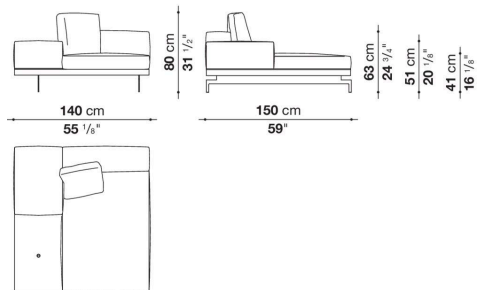

DA150LD_2

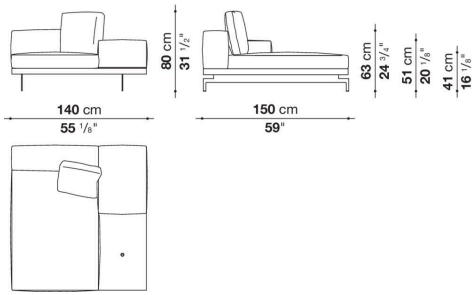

DAL150LD_2

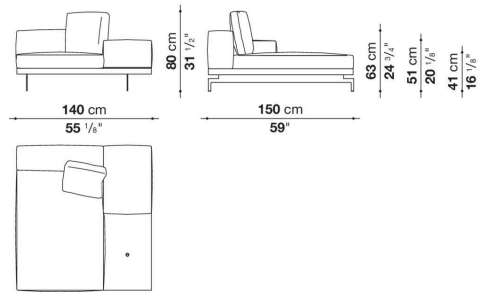

DA280P

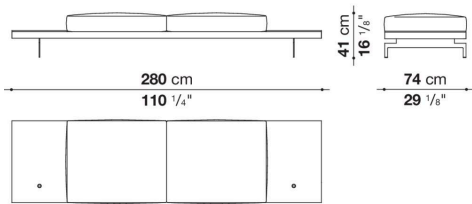

DAL280P

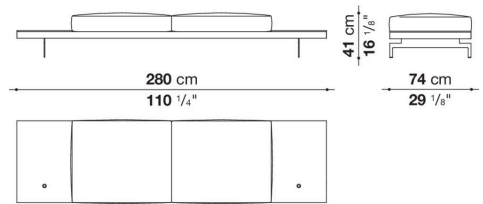

DA320PS_2

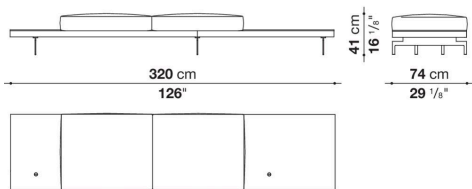

DAL320PS_2

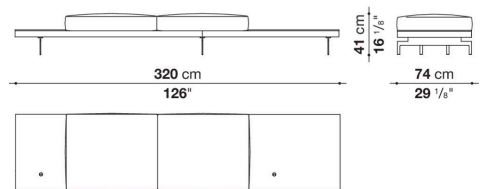

DA320PD_2

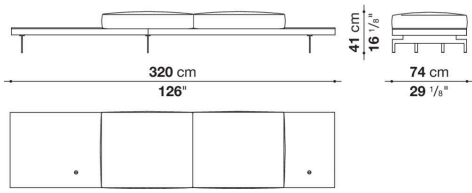

DAL320PD_2

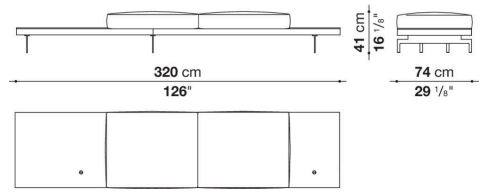

DA370P

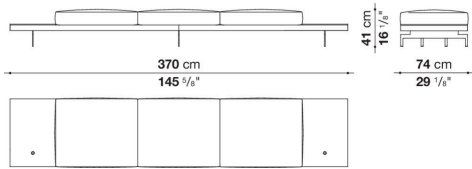

DAL370P

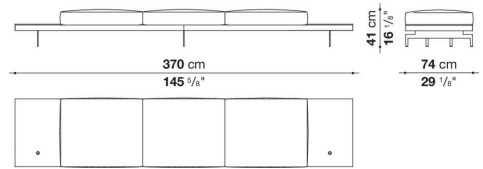

DA370PS

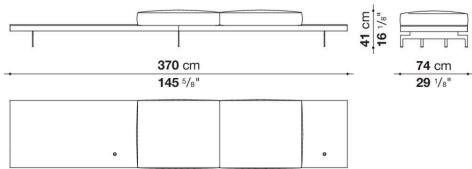

DAL370PS

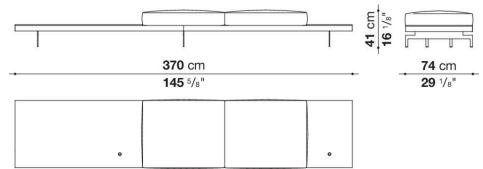

DA370PD

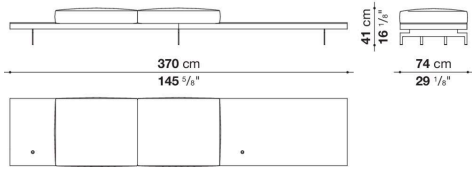

DAL370PD

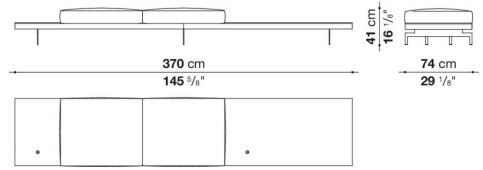

DA31B

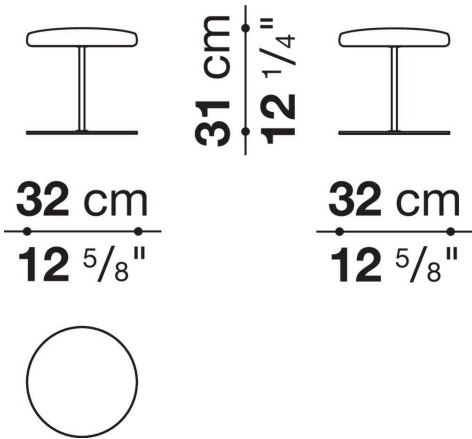

DA329D_1

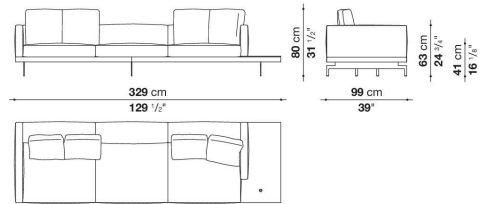

DA329D_2

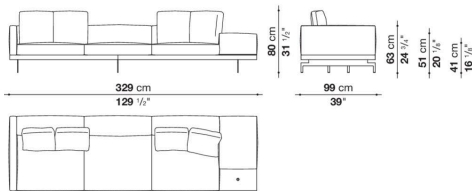

DA329S_1

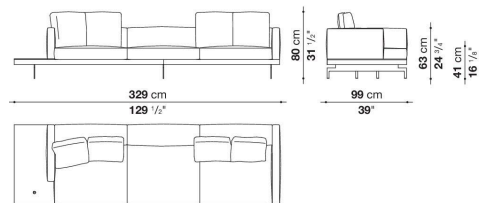

DA329S_2

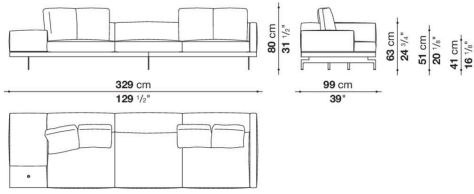

TDA31

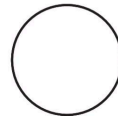
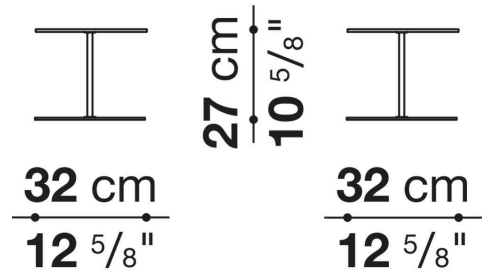

TD23R

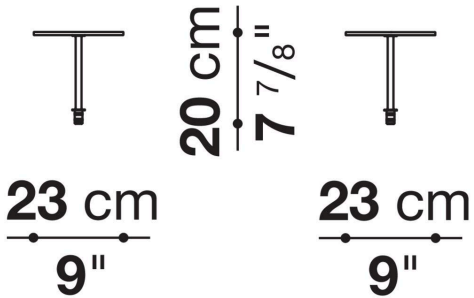

TD23RL

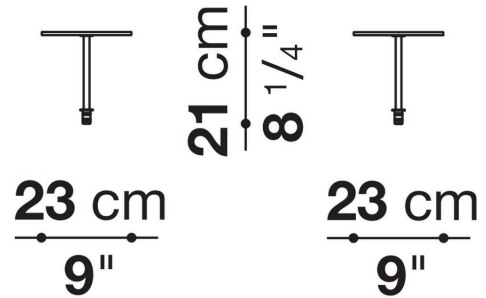

TD36

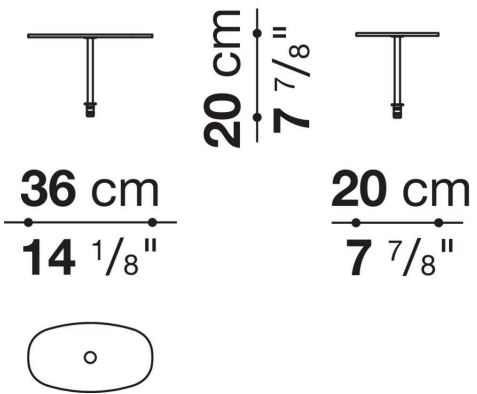

TD36L

