

Édouard

DIVANI

2016

Antonio Citterio



Description

Édouard is a series of sofas with a strong aesthetic and functional appeal designed to enhance comfort with a wide seat and a high backrest, which can also be fitted with a headrest, studied to ensure efficient and excellent ergonomic support. Édouard offers in-line and modular sofas with terminal elements, corner pieces and chaise longues and matching seating elements designed to create restful areas that suit both the space available and the personal taste. The system includes an armchair in two versions. The upholstery is in fabric or leather with elegant relief stitching.

Technical information

Internal frame

tubular steel and steel profiles

Back and armrest internal frame upholstery

Bayfit® flexible cold shaped polyurethane foam, polyester fibre

Seat cushion upholstery

shaped polyurethane of different density

Feet

aluminium

Ferrules

thermoplastic material

Cover

fabric or leather (raised stitching)

Technical drawings

ED183_V

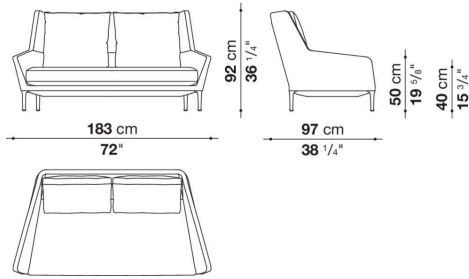

ED225_V

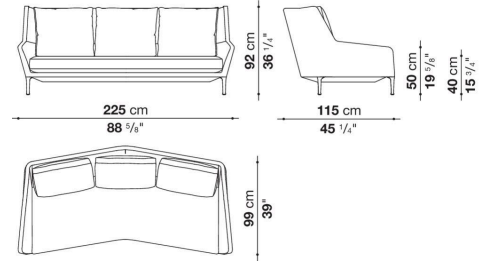

ED255_V

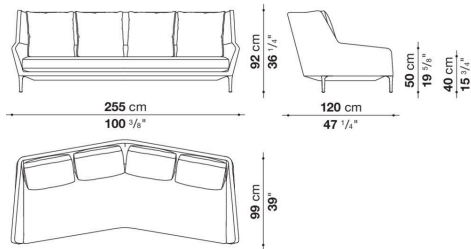

ED176TAS_V

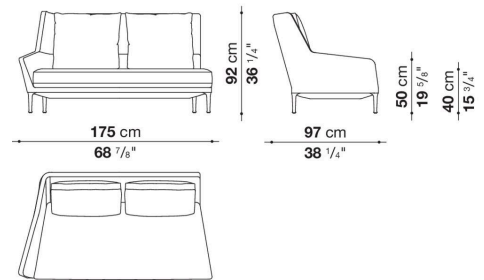

ED176TAD_V

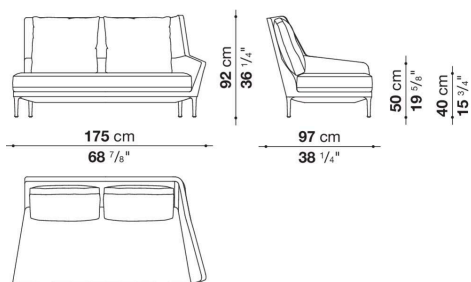

ED183LAS_V

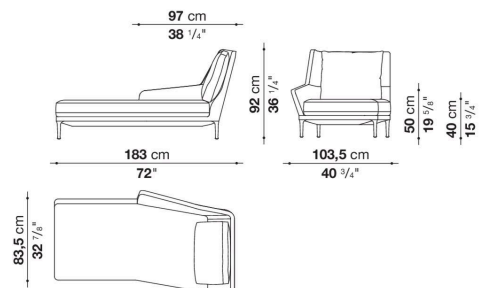

ED183LAD_V

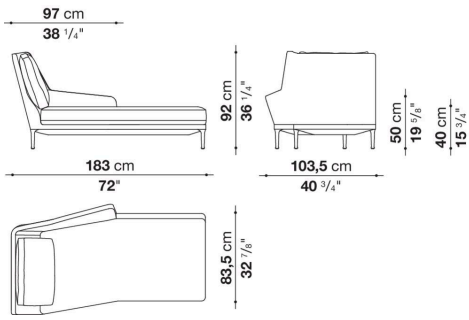

ED176TS_V

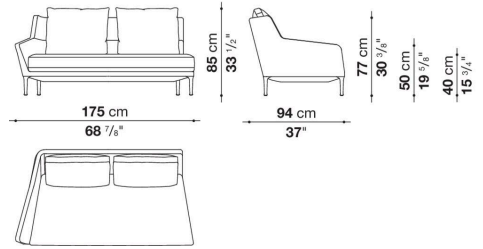

ED176TD_V

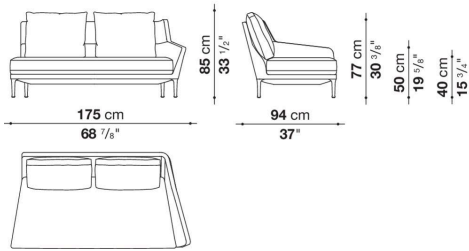

ED221TS_V

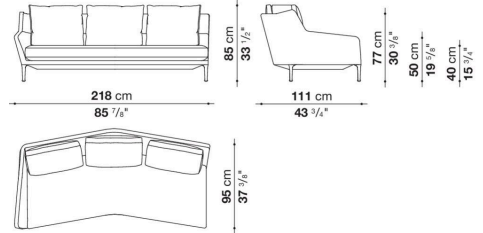

ED221TD_V

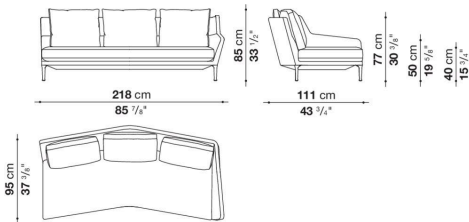

ED230AS_V

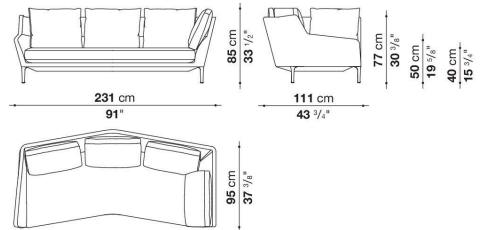

ED230AD_V

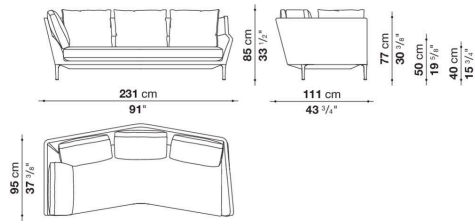

ED180LD_V

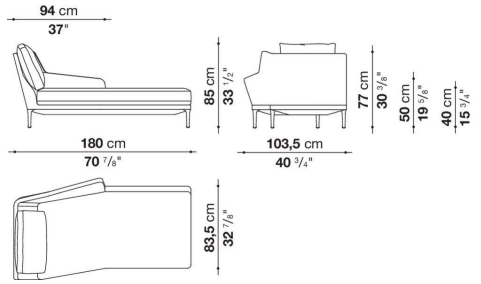

ED180LS_V

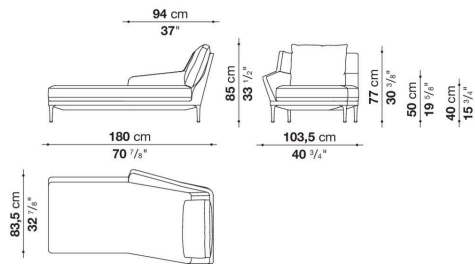

ED222LS_V

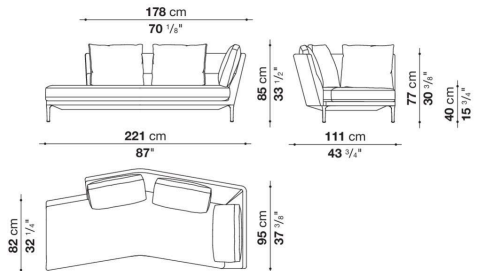

ED222LD_V

