

Saké

DIVANI

2017

Piero Lissoni



Description

Saké is a strongly contemporary seating system distinguished by a careful search for formal balance. The idea behind the line is a basic platform, magically suspended in the air like a flying carpet, with cushions to enclose the borders and feet to ground it. The seats, in three sizes, come with embracing or linear backs and armrests of various dimensions, added harmoniously to create a sofa adapted to the customer's space and personal taste. The details of the cushions and support base contribute to the design's lightness. The seat cushion has refined modular stitching; the back cushions, available in two sizes, are outlined by profiled bands. The support base is made of crosspieces with rounded steel feet connected to each other by a bar. The system also offers a sofa bed, adopting the other sofas' seating and back elements.

Technical information

Internal frame

tubular steel and steel profiles

Seat, back and armrest upholstery

Bayfit® flexible cold shaped polyurethane foam, polyester fibre cover

Back cushion (SK50C-SK75C)

combination of polyester fibre and visco-elastic polyurethane, polyester fibre cover, box style typology

Support frame

steel

Ferrules

thermoplastic material

Cover

fabric or leather

Technical drawings

SK250

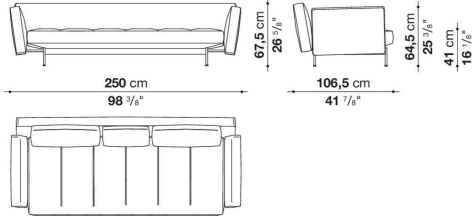

SK310

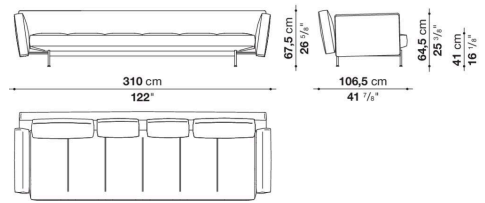

SK272C

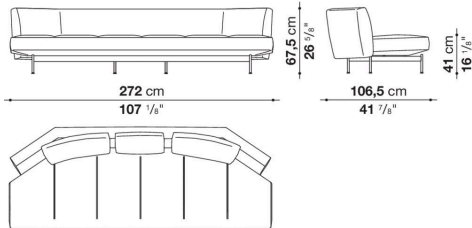

SK231CS

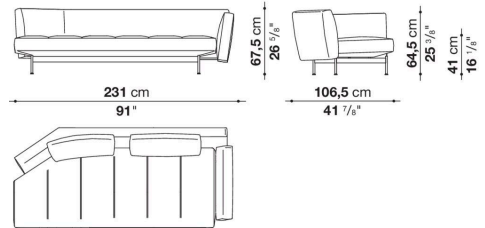

SK231CD

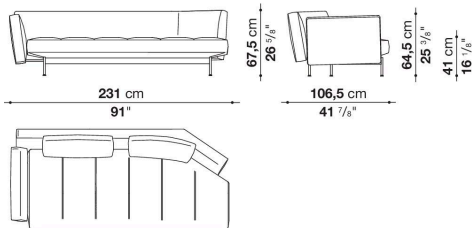

SK196TS

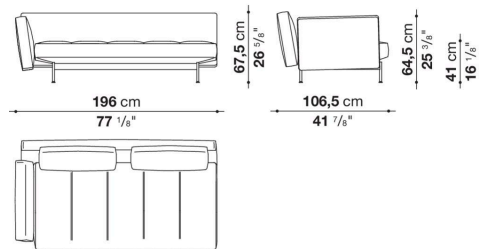

SK196TD

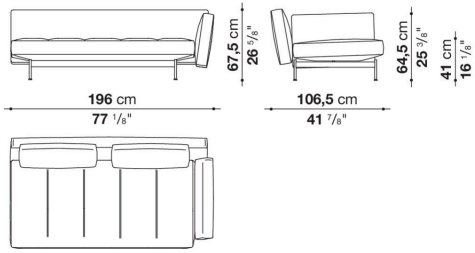

SK231TS

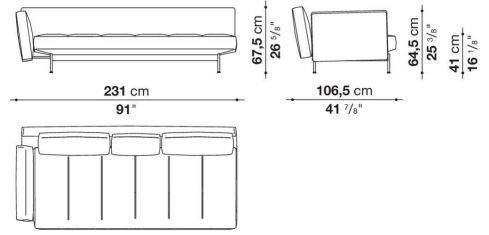

SK231TD

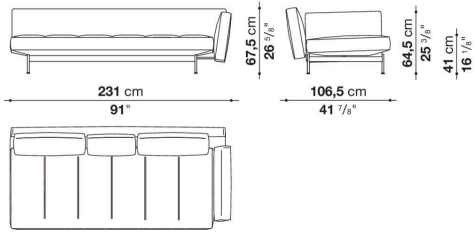

SK231TAS

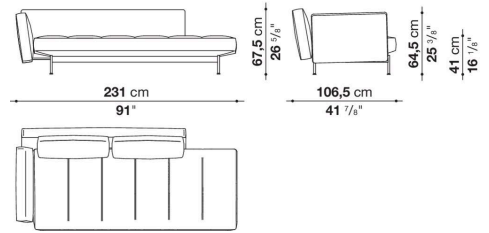

SK231TAD

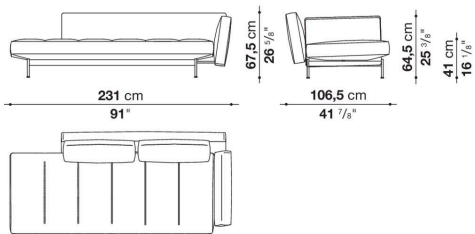

SK177TCS

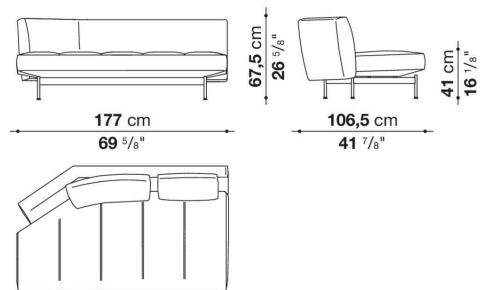

SK177TCD

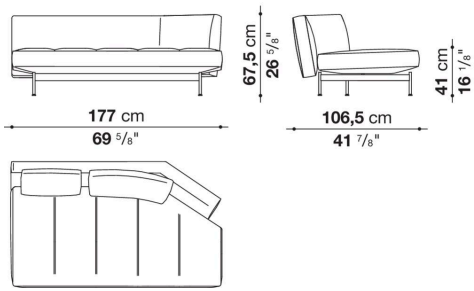

SK153LS

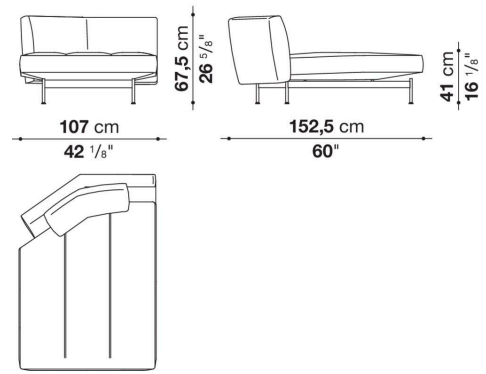

SK153LD

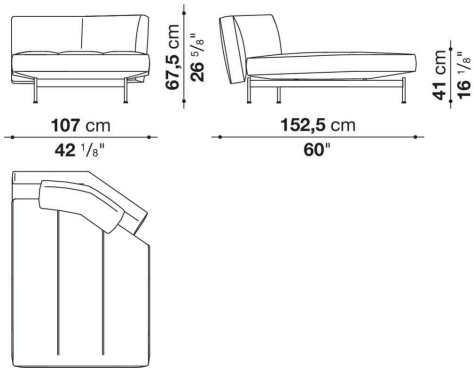

SK122PQ

