

Andy '13

DIVANI

2013

Paolo Piva



Description

Formal rigour, calibrated proportions and soft geometry characterize Andy '13, a sofa equipped with a mechanism that allows the backrest to change its inclination from a horizontal position, more decorative and with a contemporary sign, to a vertical one for more comfortable sitting. It is available in linear and corner versions with chaise longue, with fabric or leather upholstery.

Technical information

Internal frame

tubular steel and steel profiles

Internal frame upholstery

Bayfit® flexible cold shaped polyurethane foam, polyester fibre cover

Back cushion with roller (AD60CP)

down feather, polyurethane insert and polyester fibre, box style and roller typology

Frame

drawn steel and steel profiles

Profiles

tubular steel

Upright

steel sheet

Feet and ferrules

thermoplastic material

Cover

fabric (eco-leather profiles) or leather

Technical drawings

AD248

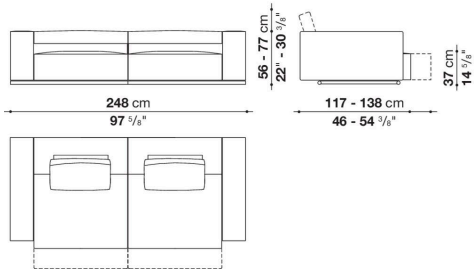

AD292

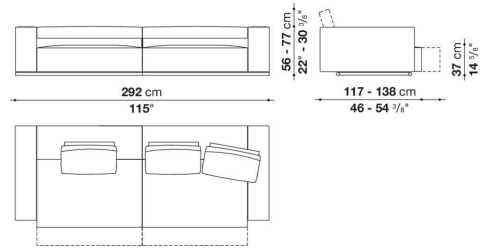

AD346

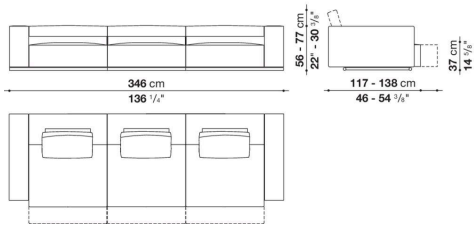

AD412

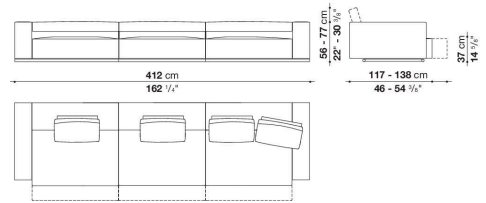

AD326AS

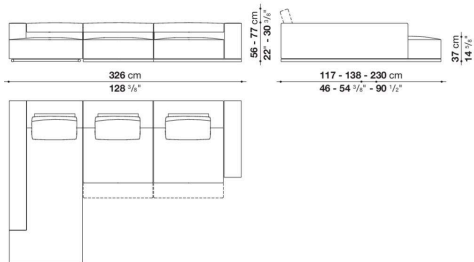

AD326AD

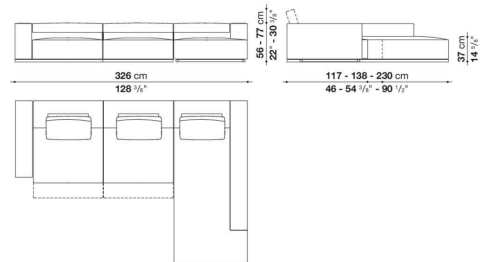

AD370AS

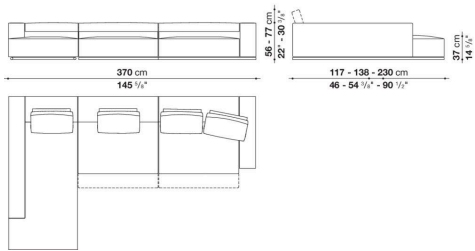

AD370AD

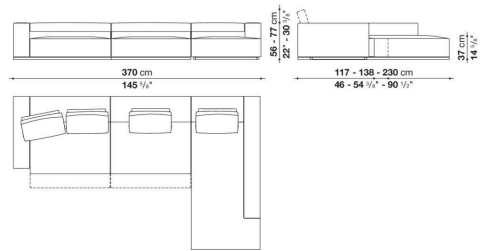

AD253S

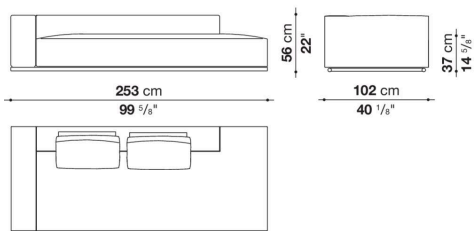

AD253D

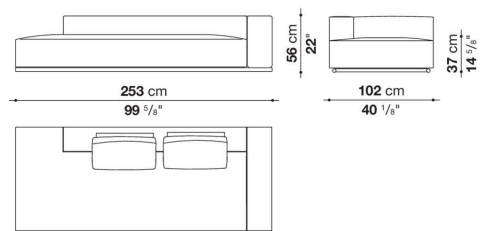

AD98P

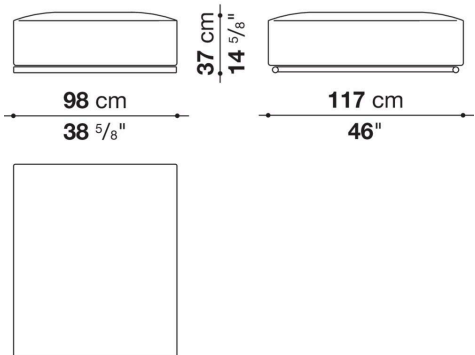

AD120P

